

Digital Fiber Sensor FX-300 SERIES

- FIBER SENSORS
- LASER SENSORS
- PHOTOELECTRIC SENSORS
- MICRO PHOTOELECTRIC SENSORS
- AREA SENSORS
- LIGHT CURTAINS / SAFETY COMPONENTS
- PRESSURE / FLOW SENSORS
- INDUCTIVE PROXIMITY SENSORS
- PARTICULAR USE SENSORS
- SENSOR OPTIONS
- SIMPLE WIRE-SAVING UNITS
- WIRE-SAVING SYSTEMS
- MEASUREMENT SENSORS
- STATIC ELECTRICITY PREVENTION DEVICES
- LASER MARKERS
- PLC
- HUMAN MACHINE INTERFACES
- ENERGY CONSUMPTION VISUALIZATION COMPONENTS
- FA COMPONENTS
- MACHINE VISION SYSTEMS
- UV CURING SYSTEMS

Related Information	■ General terms and conditions..... F-7	■ Sensor selection guide..... P.3~
	■ SC-GU1-485..... P.1009~	■ Glossary of terms..... P.1455~
	■ General precautions P.1458~	■ Korea's S-mark..... P.1506

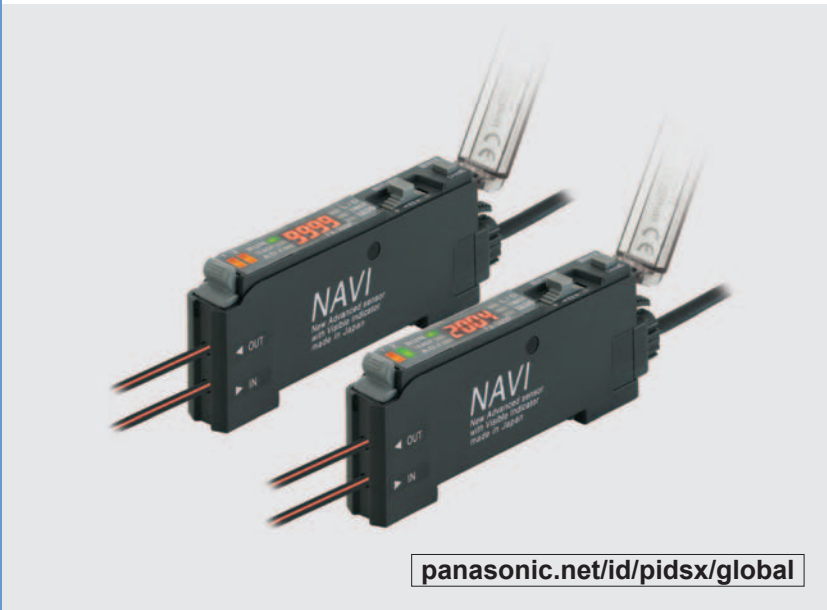

* Passed the UL 991 Environment Test

* UL 61010C-1 compatible, Passed the UL 991 Environment Test based on SEMI S2-0200. [Category applicable for semiconductor manufacturing: TWW2, Process Equipment] [Applicable standards: UL 61010C-1] [Additional test / evaluation standards as per intended use: UL 991, SEMI S2-0200]



Constant advances achieving significant improvement of sensing performance

Stable sensing over long and short periods FX-301 FX-301-HS FX-305

In addition to a "four-chemical emitting element" which suppresses changes in the light emitting element over time so that a stable level of light emission can be maintained over long periods, a "APC (Auto Power Control) circuit" has also been adopted afresh. The light emitting amount can be controlled in minute degrees so that even changes occurring over very short periods can be handled, allowing stable sensing performance by suppressing deviations in light emitting amounts caused by changes in the ambient environment that could not previously be suppressed.

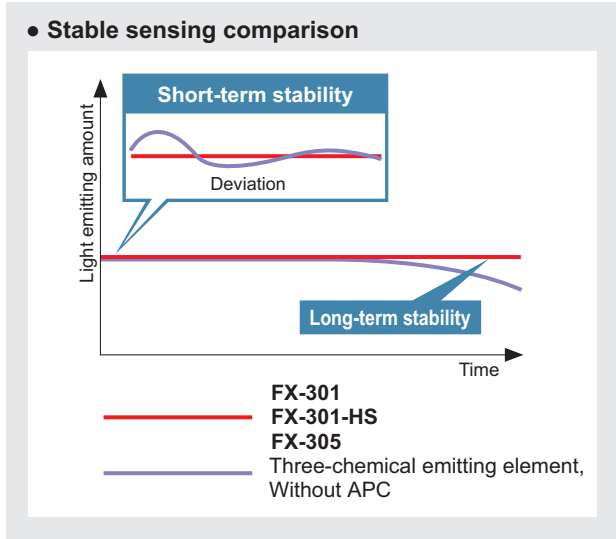

Even greater sensing range All models

Adoption of a "double coupling lens" that increases emission efficiency to its maximum limits and greatly increases sensing range. Sensing ranges with small diameter fibers and ultra-small diameter fibers, which have become very popular due to the miniaturization of chip components, have been increased by 50 % over previous values achieved with other amplifiers.

• Conventional fiber sensors (Without lens)

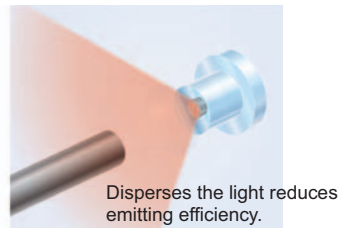

• Double coupling lens

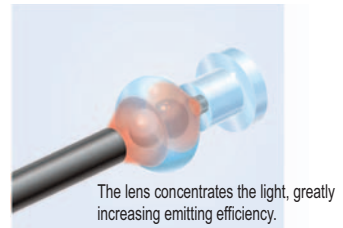

- Selection Guide
- Fibers
- Fiber Amplifiers
- FX-500
- FX-100
- FX-300
- FX-410
- FX-311
- FX-301-F7/ FX-301-F

APPLICATIONS

Detecting the presence or absence of labels

The light-emitting amount selection function can even stabilize detection of transparent labels that saturate the light-receiving level.

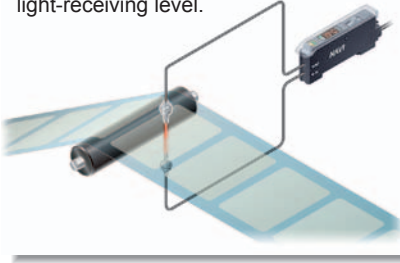

Detecting the presence or absence of ICs on a tray

You can set upper and lower limits for the threshold values using the window comparator mode and turn ON / OFF the incident light intensity within that limit.



Detecting the passage of small objects

The differential sensing mode will only detect rapid changes in the amount of light, which makes it possible for small objects to be detected.

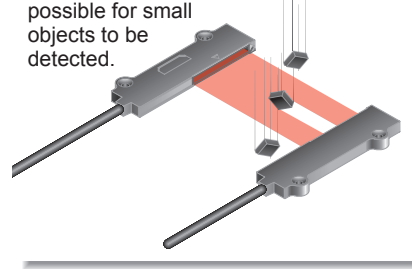

Light-emitting amount selection

FX-301 **FX-301-HS** **FX-305**

If the light receiving level becomes saturated during close-range sensing or when sensing transparent or minute objects, you can adjust the light emitting amount of the sensor to stabilize sensing **without needing to change the response time**. Sensing that previously required the response time or fibers to be changed can now be set much more easily using this function.

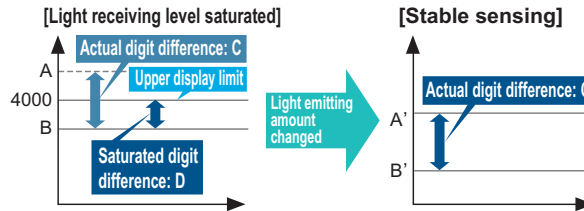

Light emitting amount can be changed without changing response time

Large display 9999

FX-305

Large display with 4 digits (9999). With a greater difference in digit value than previous models, threshold values can be set in units of 1 digit up to maximum 9999. Threshold setting can now be done more easily and accurately.



2.5 times previous models

(During STDF, LONG and U-LG modes)

Digit difference comparison

Example Digit difference between **object A** and **object B**

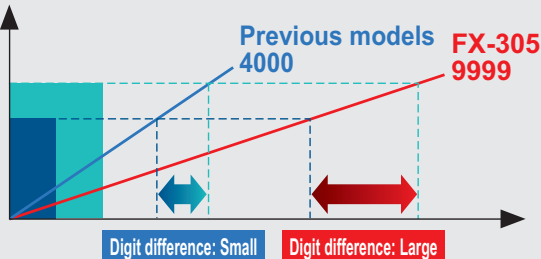

Ultra high-speed 35 μs response

FX-301-HS **FX-305**

Ultra high-speed 35 μs response. Even small objects moving at high speeds can be sensed. In addition, at 65 μs the **FX-301** standard type and **FX-305** high-function type is also twice as fast as previous models.

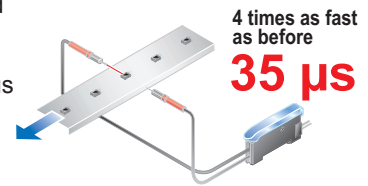

Ultra high-speed type FX-301-HS

(H-SP mode)

35 μs

Standard type FX-301, High-function type FX-305

(H-SP mode)

65 μs

Previous model

150 μs

FIBER SENSORS

LASER SENSORS

PHOTOELECTRIC SENSORS

MICRO PHOTOELECTRIC SENSORS

AREA SENSORS

LIGHT CURTAINS / SAFETY COMPONENTS

PRESSURE / FLOW SENSORS

INDUCTIVE PROXIMITY SENSORS

PARTICULAR USE SENSORS

SENSOR OPTIONS

SIMPLE WIRE-SAVING UNITS

WIRE-SAVING SYSTEMS

MEASUREMENT SENSORS

STATIC ELECTRICITY PREVENTION DEVICES

LASER MARKERS

PLC

HUMAN MACHINE INTERFACES

ENERGY CONSUMPTION VISUALIZATION COMPONENTS

FA COMPONENTS

MACHINE VISION SYSTEMS

UV CURING SYSTEMS

Selection Guide

Fibers

Fiber Amplifiers

FX-500

FX-100

FX-300

FX-410

FX-311

FX-301-F7/ FX-301-F

FIBER SENSORS

LASER SENSORS

PHOTOELECTRIC SENSORS

MICRO PHOTOELECTRIC SENSORS

AREA SENSORS

LIGHT CURTAINS / SAFETY COMPONENTS

PRESSURE / FLOW SENSORS

INDUCTIVE PROXIMITY SENSORS

PARTICULAR USE SENSORS

SENSOR OPTIONS

SIMPLE WIRE-SAVING UNITS

WIRE-SAVING SYSTEMS

MEASUREMENT SENSORS

STATIC ELECTRICITY PREVENTION DEVICES

LASER MARKERS

PLC

HUMAN MACHINE INTERFACES

ENERGY CONSUMPTION VISUALIZATION COMPONENTS

FA COMPONENTS

MACHINE VISION SYSTEMS

UV CURING SYSTEMS

Simplified systems using new operating modes

FX-305

A window comparator mode and differential sensing mode have been added. These modes make it easy to carry out sensing tasks that previously required multiple sensors or involved complex threshold settings.

• **Window comparator mode**



<Sensing ICs in trays>

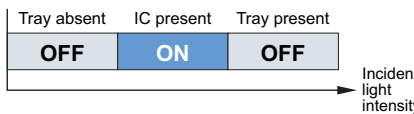
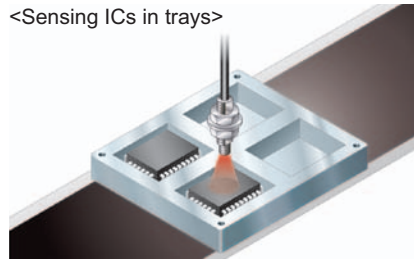

Upper and lower limits for threshold values can be set so that the incident light intensity can turn on and off within those ranges. Single output is used, so that only one cable is required, and no PLC processing is required either.

• **Differential sensing mode**



<Sensing of tiny moving objects>

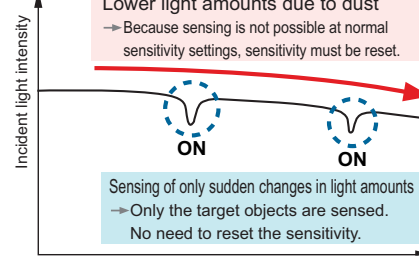
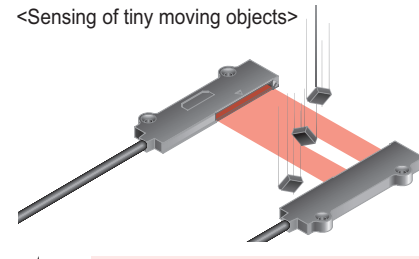

Equipped with 5 types timers

FX-305

The **FX-305** includes the same ON-delay / OFF-delay / ONE SHOT timer as the **FX-301(-HS)**, as well as an ON-delay • OFF-delay timer and an ON-delay • ONE SHOT timer. A wide variety of timer control operations can be carried out by these fiber sensors alone.

Timer period
Output 1: 0.5 to 9,999 ms (variable)
Output 2: 0.5 to 500 ms (variable)

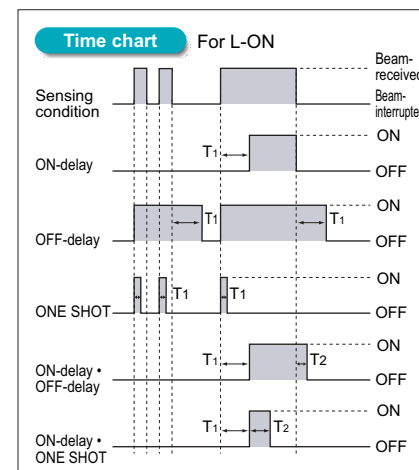

Even beginners can quickly learn how to use the MODE NAVI

All models

MODE NAVI uses six indicators to display the amplifier's basic operations. The current operating mode can be confirmed at a glance, so even a first time user can easily operate the amplifier without becoming confused.

RUN	TEACH	ADJ	RUN → This is the sensing mode. Incident light level is displayed in the digital display.
RUN	TEACH	ADJ	TEACH → This mode is for setting the threshold value.
RUN	TEACH	ADJ	ADJ → In this mode, the threshold value, once set, may be fine-tuned.



L/D	TIMER	L/D ON → This mode allows the selection of output operation as either Light-ON or Dark-ON.
L/D	TIMER	TIMER → This mode permits the choice of using or not using the timer.
L/D	TIMER	PRO → This mode allows the selection of further advanced functions, such as the copying of individual settings and the memory functions.

Easy confirming of threshold value settings

FX-301 FX-301-HS FX-305

The threshold value can be confirmed by turning the jog switch even during RUN mode.

Jog switch is turned
Left: **FX-301(-HS)** Right: Output 2 for **FX-305**

The threshold value is displayed

Selection Guide

Fibers

Fiber Amplifiers

FX-500

FX-100

FX-300

FX-410

FX-311

FX-301-F7/ FX-301-F

The use of only two switches makes for very simple operations

All models

Only two switches, the large jog switch and the large MODE key, are required for operation. You can operate it simply by the 3 steps shown on the right.

• **Large MODE key**



1

MODE Pressing the switch selects or cancels the operating mode

• **Large jog switch**

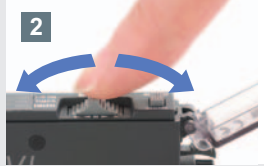

2

Moving the switch from side to side allows items to be selected



3

Pressing the switch then confirms the selected setting

A quick-connection cable saves wiring and work-hours

Connector type

One unit can be used as either a main unit or sub unit

The amplifier unit can be used as either a main unit or a sub unit. This feature allows for easy mounting in the side-by-side configuration. The main and sub unit functions are distinguished only by the proper use of the main cable and the sub cable. Moreover, inventory management and maintenance is simplified.

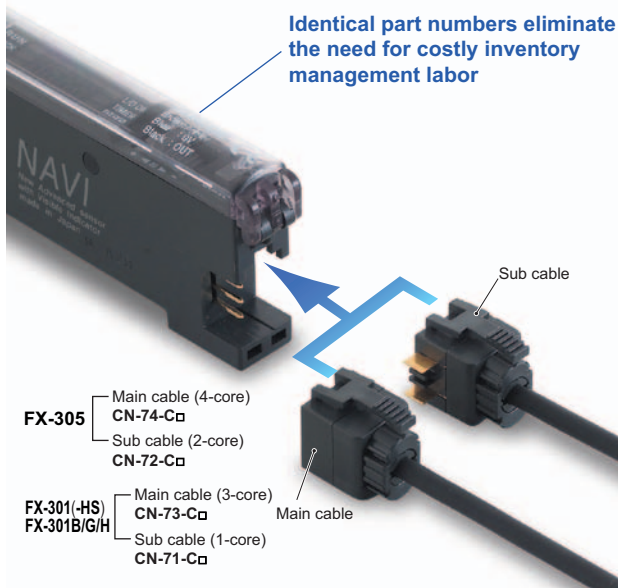

Identical part numbers eliminate the need for costly inventory management labor

<p>FX-305</p> <ul style="list-style-type: none"> Main cable (4-core) CN-74-C□ Sub cable (2-core) CN-72-C□ 	<p>Sub cable</p> <p>Main cable</p>
<p>FX-301(-HS) FX-301B/G/H</p> <ul style="list-style-type: none"> Main cable (3-core) CN-73-C□ Sub cable (1-core) CN-71-C□ 	

An optical communication function allows up to *16 sensors to be adjusted simultaneously

FX-301 | FX-305

The optical communication function allows the data that is currently set to be copied and saved all at once for all amplifiers connected together from the right side. This greatly reduces troublesome setup tasks and makes setup much smoother. In addition, troublesome adjustment operations at times such as when replacing sensors can also be carried out easily and data can also be copied and stored using the optical communication function.



* Use the optical communication function for only the same types of sensors. Furthermore, the FX-301-HS is not equipped with optical communication function capability.

Settings can be entered directly using numerical input

All models

Every function can be directly set merely by the input of a four digit code (numbers) from the code table. This convenient feature is easy to set up. In the event that settings are accidentally changed at the operating site, merely entering the correct code can restore the original settings. This results in easy and quick maintenance.

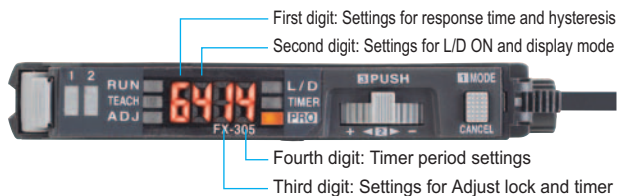

- First digit: Settings for response time and hysteresis
- Second digit: Settings for L/D ON and display mode
- Third digit: Settings for Adjust lock and timer
- Fourth digit: Timer period settings

Communication unit improves equipment starting up and maintenance

FX-301 | FX-305

External input unit for digital sensor

FX-CH2

Teaching and changing settings can be performed by using the PLC and touch panel.

Various settings and switching of up to 16 units of digital fiber sensors can be accomplished at once without operating the actual sensors themselves, but via external signals, such as the PLC, touch panel, and push buttons.

<Main functions>

- Batch teaching
- Key lock setting
- Batch loading / saving of the data bank



Refer to our website for details

Upper communication unit for digital sensor

SC-GU1-485

We now offer remote maintenance for digital sensors!

The communication unit enables inputs to the digital fiber sensors (such as teaching and data bank switching) to be carried out via a PLC or a personal computer, and also allows confirming of the incident light intensity an output status for the fiber sensors. This greatly improves workability during equipment starting up and maintenance.

<Communicable commands>

- Sensor incident light intensity
- Sensor settings verification
- Sensor output status
- Threshold value settings, etc.

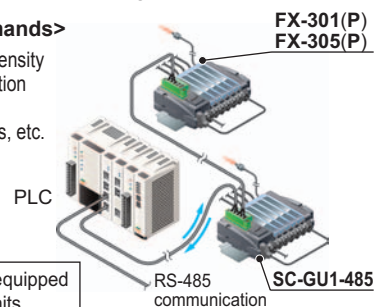

Compatible with all PLCs equipped with RS-485 compatible units

Refer to **SC-GU1-485** pages for details

FIBER SENSORS

LASER SENSORS

PHOTOELECTRIC SENSORS

MICRO PHOTOELECTRIC SENSORS

AREA SENSORS

LIGHT CURTAINS / SAFETY COMPONENTS

PRESSURE / FLOW SENSORS

INDUCTIVE PROXIMITY SENSORS

PARTICULAR USE SENSORS

SENSOR OPTIONS

SIMPLE WIRE-SAVING UNITS

WIRE-SAVING SYSTEMS

MEASUREMENT SENSORS

STATIC ELECTRICITY PREVENTION DEVICES

LASER MARKERS

PLC

HUMAN MACHINE INTERFACES

ENERGY CONSUMPTION VISUALIZATION COMPONENTS

FA COMPONENTS

MACHINE VISION SYSTEMS

UV CURING SYSTEMS

Selection Guide

Fibers

Fiber Amplifiers

FX-500

FX-100

FX-300

FX-410

FX-311

FX-301-F7/ FX-301-F

ORDER GUIDE

Amplifiers Quick-connection cable is not supplied with the amplifier. Please order it separately.

Type	Appearance	Model No.	Emitting element	Output	Quick-connection cables				
					Type	Model No.	Length		
Standard type		FX-301	Red LED	NPN open-collector transistor	Main cable (3-core)	CN-73-C1	1 m 3.281 ft		
		FX-301P		PNP open-collector transistor					
		FX-301B	Blue LED	NPN open-collector transistor		CN-73-C2	2 m 6.562 ft		
		FX-301BP		PNP open-collector transistor					
		FX-301G	Green LED	NPN open-collector transistor		CN-73-C5	5 m 16.404 ft		
		FX-301GP		PNP open-collector transistor					
		FX-301H	Infrared LED	NPN open-collector transistor	CN-71-C1	1 m 3.281 ft			
		FX-301HP		PNP open-collector transistor					
		High-speed type		FX-301-HS	Red LED	NPN open-collector transistor	Sub cable (1-core)	CN-71-C2	2 m 6.562 ft
				FX-301P-HS		PNP open-collector transistor			
High-function type		FX-305	Red LED	NPN open-collector transistor	Main cable (4-core)	CN-74-C1	1 m 3.281 ft		
				CN-74-C2		2 m 6.562 ft			
				CN-74-C5		5 m 16.404 ft			
		FX-305P		PNP open-collector transistor	Sub cable (2-core)	CN-72-C1	1 m 3.281 ft		
						CN-72-C2	2 m 6.562 ft		
CN-72-C5	5 m 16.404 ft								

ORDER GUIDE

Quick-connection cables

For FX-301(-HS)/B/G/H Quick-connection cable is not supplied with the amplifier. Please order it separately.

Type	Model No.	Length	Description
Main cable (3-core)	CN-73-C1	Length: 1 m 3.281 ft	0.2 mm ² 3-core cabtyre cable, with connector on one end Cable outer diameter: \varnothing 3.3 mm \varnothing 0.130 in
	CN-73-C2	Length: 2 m 6.562 ft	
	CN-73-C5	Length: 5 m 16.404 ft	
Sub cable (1-core)	CN-71-C1	Length: 1 m 3.281 ft	0.2 mm ² 1-core cabtyre cable, with connector on one end Cable outer diameter: \varnothing 3.3 mm \varnothing 0.130 in
	CN-71-C2	Length: 2 m 6.562 ft	
	CN-71-C5	Length: 5 m 16.404 ft	

Main cable

- **CN-73-C□**

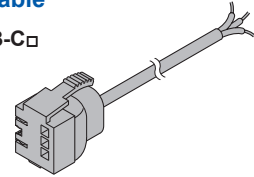

Sub cable

- **CN-71-C□**

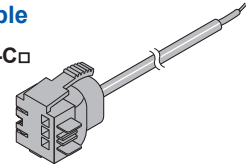

For FX-305 Quick-connection cable is not supplied with the amplifier. Please order it separately.

Type	Model No.	Length	Description
Main cable (4-core)	CN-74-C1	Length: 1 m 3.281 ft	0.2 mm ² 4-core cabtyre cable, with connector on one end Cable outer diameter: \varnothing 3.3 mm \varnothing 0.130 in
	CN-74-C2	Length: 2 m 6.562 ft	
	CN-74-C5	Length: 5 m 16.404 ft	
Sub cable (2-core)	CN-72-C1	Length: 1 m 3.281 ft	0.2 mm ² 2-core cabtyre cable, with connector on one end Cable outer diameter: \varnothing 3.3 mm \varnothing 0.130 in
	CN-72-C2	Length: 2 m 6.562 ft	
	CN-72-C5	Length: 5 m 16.404 ft	

Main cable

- **CN-74-C□**

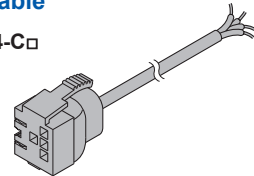

Sub cable

- **CN-72-C□**

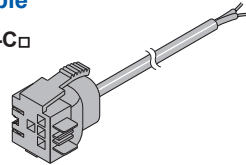

End plates End plates are not supplied with the amplifier. Please order them separately when the amplifiers are mounted in cascade.

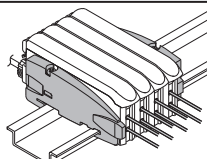
Appearance	Model No.	Description
	MS-DIN-E	When cascading multiple amplifiers, or when it moves depending on the way it is installed on a DIN rail, these end plates clamp amplifiers into place on both sides. Make sure to use end plates when cascading multiple amplifiers together. Two pcs. per set

OPTIONS

Designation	Model No.	Description
Amplifier mounting bracket	MS-DIN-2	Mounting bracket for amplifier
Fiber amplifier protection seal	FX-MB1	10 sets of 2 communication window seals and 1 connector seal Communication window seal: It prevents malfunction due to transmission signal from another amplifier, as well as, prevents effect on another amplifier. Connector seal: It prevents contact of any metal, etc., with the pins of the quick-connection cable.

Note: Fiber amplifier protection seals are supplied with the **FX-301(P)** and **FX-305(P)**.

Amplifier mounting bracket

- **MS-DIN-2**

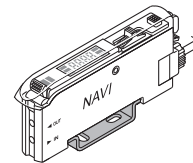

Fiber amplifier protection seal

- **FX-MB1**

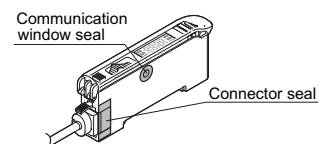

FIBER SENSORS

LASER SENSORS

PHOTO-ELECTRIC SENSORS

MICRO PHOTO-ELECTRIC SENSORS

AREA SENSORS

LIGHT CURTAINS / SAFETY COMPONENTS

PRESSURE / FLOW SENSORS

INDUCTIVE PROXIMITY SENSORS

PARTICULAR USE SENSORS

SENSOR OPTIONS

SIMPLE WIRE-SAVING UNITS

WIRE-SAVING SYSTEMS

MEASUREMENT SENSORS

STATIC ELECTRICITY PREVENTION DEVICES

LASER MARKERS

PLC

HUMAN MACHINE INTERFACES

ENERGY CONSUMPTION VISUALIZATION COMPONENTS

FA COMPONENTS

MACHINE VISION SYSTEMS

UV CURING SYSTEMS

Selection Guide

Fibers

Fiber Amplifiers

FX-500

FX-100

FX-300

FX-410

FX-311

FX-301-F7/
FX-301-F

LIST OF FIBERS

FIBER SENSORS

LASER SENSORS

PHOTO-ELECTRIC SENSORS

MICRO PHOTO-ELECTRIC SENSORS

AREA SENSORS

LIGHT CURTAINS / SAFETY COMPONENTS

PRESSURE / FLOW SENSORS

INDUCTIVE PROXIMITY SENSORS

PARTICULAR USE SENSORS

SENSOR OPTIONS

SIMPLE WIRE-SAVING UNITS

WIRE-SAVING SYSTEMS

MEASUREMENT SENSORS

STATIC ELECTRICITY PREVENTION DEVICES

LASER MARKERS

PLC

HUMAN MACHINE INTERFACES

ENERGY CONSUMPTION VISUALIZATION COMPONENTS

FA COMPONENTS

MACHINE VISION SYSTEMS

UV CURING SYSTEMS

Selection Guide

Fibers

Fiber Amplifiers

FX-500

FX-100

FX-300

FX-410

FX-311

FX-301-F7 / FX-301-F

FX-301 / FX-305 (Red LED type) sensing range (Note 1)

Thru-beam type (one pair set)



The **FX-305** and **FX-301(-HS)** have different sensing modes.
FX-305: H-SP, FAST, STD, STDF, LONG, U-LG (no S-D mode)
FX-301(-HS): S-D, H-SP (Note 1), FAST, STD, LONG (no STDF or U-LG mode)

Fibers are listed in alphabetic order. Refer to p.5~ "Fiber Selection" for details of each fiber.

Model No.	Sensing range (mm in) (Note 2)								Dimensions
	Red LED								
	U-LG	LONG	STDF	STD	FAST	H-SP	S-D		
FT-140	19,600 771.654 (Note 3)	19,600 771.654 (Note 3)	19,600 771.654 (Note 3)	16,000 629.921	16,000 629.921	8,700 342.520	8,700 342.520	P.51	
FT-30	450 17.717	310 12.205	210 8.268	150 5.906	110 4.331	60 2.362	60 2.362	P.51	
FT-31	440 17.323	290 11.417	200 7.874	142 5.591	105 4.134	58 2.283	49 1.929	P.51	
FT-31S	440 17.323	290 11.417	200 7.874	140 5.512	100 3.937	55 2.165	49 1.929	P.51	
FT-31W	300 11.811	230 9.055	130 5.118	100 3.937	65 2.559	30 1.181	30 1.181	P.51	
FT-40	1,300 51.181	900 35.433	600 23.622	450 17.717	330 12.992	180 7.087	180 7.087	P.51	
FT-42	1,100 43.307	800 31.496	550 21.654	400 15.748	285 11.220	160 6.299	150 5.906	P.51	
FT-42S	1,100 43.307	800 31.496	550 21.654	400 15.748	285 11.220	160 6.299	150 5.906	P.51	
FT-42W	1,000 39.370	710 27.953	460 18.110	330 12.992	240 9.449	130 5.118	130 5.118	P.51	
FT-43	1,900 74.803	1,400 55.118	800 31.496	610 24.016	440 17.323	240 9.449	250 9.843	P.51	
FT-45X	1,600 62.992 (Note 3)	1,100 43.307	780 30.709	570 22.441	410 16.142	230 9.055	230 9.055	P.52	
FT-A11	3,600 141.732 (Note 3)	3,600 141.732 (Note 3)	3,600 141.732 (Note 3)	2,700 106.299	1,800 70.866	1,100 43.307	1,000 39.370	P.52	
FT-A11W	3,600 141.732 (Note 3)	3,600 141.732 (Note 3)	3,600 141.732 (Note 3)	3,100 122.047	2,300 90.551	1,200 47.244	1,200 47.244	P.52	
FT-A32	3,600 141.732 (Note 3)	3,600 141.732 (Note 3)	3,600 141.732 (Note 3)	3,600 141.732 (Note 3)	3,600 141.732 (Note 3)	2,900 114.173	2,900 114.173	P.52	
FT-A32W	3,600 141.732 (Note 3)	3,600 141.732 (Note 3)	3,600 141.732 (Note 3)	3,600 141.732 (Note 3)	3,600 141.732 (Note 3)	2,000 78.740	2,100 82.677	P.52	
FT-AL05	760 29.921	680 26.772	340 13.386	330 12.992	230 9.055	130 5.118	130 5.118	P.52	
FT-E13	20 0.787	13 0.512	9 0.354	6 0.236	5 0.197	2 0.079	2 0.079	P.52	
FT-E23	95 3.740	65 2.559	42 1.654	31 1.220	22 0.866	12 0.472	12 0.472	P.52	
FT-H13-FM2	1,200 47.244	880 34.646	550 21.654	440 17.323	300 11.811	150 5.906	155 6.102	P.52	
FT-H20-J20-S (Note 4)	530 20.866	390 15.354	225 8.858	200 7.874	140 5.512	60 2.362	60 2.362	P.53	
FT-H20-J30-S (Note 4)	530 20.866	390 15.354	225 8.858	200 7.874	140 5.512	60 2.362	60 2.362	P.53	
FT-H20-J50-S (Note 4)	530 20.866	390 15.354	225 8.858	200 7.874	140 5.512	60 2.362	60 2.362	P.53	
FT-H20-M1	750 29.528	550 21.654	320 12.598	280 11.024	200 7.874	85 3.346	90 3.543	P.53	
FT-H20-VJ50-S (Note 4)	840 33.071	550 21.654	370 14.567	280 11.024	200 7.874	90 3.543	90 3.543	P.53	
FT-H20-VJ80-S (Note 4)	840 33.071	550 21.654	370 14.567	280 11.024	200 7.874	90 3.543	90 3.543	P.53	
FT-H20W-M1	420 16.535	310 12.205	180 7.087	140 5.512	100 3.937	40 1.575	50 1.969	P.53	
FT-H30-M1V-S (Note 5)	350 13.78	250 9.843	150 5.906	125 4.921	90 3.543	50 1.969	40 1.575	P.53	
FT-H35-M2	750 29.528	550 21.654	330 12.992	280 11.024	200 7.874	85 3.346	90 3.543	P.53	
FT-H35-M2S6	750 29.528	550 21.654	330 12.992	280 11.024	200 7.874	85 3.346	90 3.543	P.53	
FT-HL80Y	3,500 137.795 (Note 3)	3,500 137.795 (Note 3)	1,800 70.866	1,350 53.150	900 35.433	450 17.717	480 18.898	P.53	
FT-KS40	3,600 141.732 (Note 3)	3,600 141.732 (Note 3)	3,600 141.732 (Note 3)	2,700 106.299	1,900 74.803	1,000 39.370	850 33.465	P.54	
FT-KV26	800 31.496	710 27.953	340 13.386	310 12.205	20 0.787	120 4.724	120 4.724	P.54	
FT-KV40	3,600 141.732 (Note 3)	3,600 141.732 (Note 3)	3,200 125.984	2,500 98.425	1,800 70.866	1,000 39.370	1,000 39.370	P.54	
FT-KV40W	3,600 141.732 (Note 3)	3,600 141.732 (Note 3)	3,200 125.984	2,000 78.740	1,400 55.118	790 31.102	810 31.890	P.54	
FT-L80Y	3,500 137.795	3,500 137.795	2,000 78.740	1,500 59.055	1,000 39.370	500 19.685	530 20.866	P.54	

- Notes: 1) Please contact our office about the sensing ranges for **FX-301-HS** in H-SP mode.
 2) Note that the sensing range of the free-cut type fiber may be reduced by 20 % max. depending upon how the fiber is cut.
 3) The fiber cable length practically limits the sensing range.
 4) Heat-resistant joint fibers and ordinary-temperature fibers (**FT-42**) are sold as a set.
 5) Sold as a set comprising vacuum type fiber + photo-terminal (**FV-BR1**) + fiber at atmospheric side (**FT-J8**).

LIST OF FIBERS

FX-301 / FX-305 (Red LED type) sensing range (Note 1)

Thru-beam type (one pair set) 

The **FX-305** and **FX-301(-HS)** have different sensing modes.
FX-305: H-SP, FAST, STD, STDF, LONG, U-LG (no S-D mode)
FX-301(-HS): S-D, H-SP (Note 1), FAST, STD, LONG (no STDF or U-LG mode)

Fibers are listed in alphabetic order. Refer to p.5~ "Fiber Selection" for details of each fiber.

Model No.	Sensing range (mm in) (Note 2)												Dimensions		
	Red LED														
	U-LG		LONG		STDF		STD		FAST		H-SP			S-D	
FT-R31	340	13.386	290	11.417	150	5.906	130	5.118	95	3.740	49	1.929	49	1.929	P.54
FT-R40	1,000	39.370	710	27.953	470	18.504	330	12.992	240	9.449	130	5.118	130	5.118	P.54
FT-R41W	1,000	39.370	710	27.953	460	18.110	330	12.992	240	9.449	130	5.118	130	5.118	P.54
FT-R42W	2,800	110.236	1,600	62.992	890	35.039	770	30.315	560	22.047	310	12.205	320	12.598	P.54
FT-R43	1,000	39.370	710	27.953	450	17.717	290	11.417	210	8.268	110	4.331	110	4.331	P.54
FT-R44Y	1,000	39.370	710	27.958	450	17.717	290	11.417	210	8.268	110	4.330	110	4.330	P.55
FT-R60Y	2,650	104.330	1,800	70.866	1,200	47.244	830	32.677	610	24.016	335	13.189	350	13.780	P.55
FT-S11	100	3.937	80	3.150	50	1.969	31	1.220	22	0.866	13	0.512	14	0.551	P.55
FT-S20	450	17.717	310	12.205	210	8.268	150	5.906	110	4.331	60	2.362	60	2.362	P.55
FT-S21	440	17.323	290	11.417	200	7.874	142	5.591	105	4.134	58	2.283	49	1.929	P.55
FT-S21W	300	11.811	230	9.055	130	5.118	100	3.937	65	2.559	30	1.181	30	1.181	P.55
FT-S30	1,300	51.181	900	35.433	600	23.622	450	17.717	330	12.992	180	7.087	180	7.087	P.55
FT-S31W	1,000	39.370	710	27.953	460	18.110	330	12.992	240	9.449	130	5.118	130	5.118	P.55
FT-S32	3,600	141.732	2,400	94.488	1,500	59.055	1,100	43.307	840	33.071	460	18.110	510	20.079	P.55
FT-V23	590	23.228	380	14.961	270	10.630	170	6.693	125	4.921	60	2.362	63	2.480	P.55
FT-V24W	120	4.724	90	3.543	55	2.165	40	1.575	30	1.181	13	0.512	15	0.591	P.56
FT-V25	310	12.205	200	7.874	130	5.118	90	3.543	60	2.362	35	1.378	35	1.378	P.56
FT-V30	620	24.409	420	16.535	270	10.630	200	7.874	140	5.512	70	2.756	70	2.756	P.56
FT-V40	3,600	141.732 (Note 3)	3,600	141.732 (Note 3)	1,600	62.992	1,700	66.929	1,200	47.244	680	26.772	690	27.165	P.56
FT-V80Y	1,000	39.370	800	31.496	500	19.685	400	15.748	280	11.024	120	4.724	140	5.512	P.56
FT-Z20HBW	400	15.748	290	11.417	160	6.299	130	5.118	90	3.543	50	1.969	50	1.969	P.56
FT-Z20W	830	32.677	570	22.441	370	14.567	250	9.843	180	7.087	90	3.543	90	3.543	P.56
FT-Z30	2,600	102.362	1,900	74.803	1,100	43.307	850	33.465	620	24.409	330	12.992	340	13.386	P.56
FT-Z30E	3,600	141.732 (Note 3)	3,100	122.047	2,100	82.677	1,600	62.992	1,100	43.307	650	25.591	670	26.378	P.56
FT-Z30EW	3,600	141.732 (Note 3)	2,700	106.299	1,400	55.118	1,200	47.244	900	35.433	500	19.685	500	19.685	P.57
FT-Z30H	3,600	141.732 (Note 3)	3,100	122.047	2,200	86.614	1,600	62.992	1,100	43.307	650	25.591	670	26.378	P.57
FT-Z30HW	3,600	141.732 (Note 3)	3,100	122.047	2,200	86.614	1,500	59.055	1,000	39.370	590	23.228	610	24.016	P.57
FT-Z30W	2,000	78.740	1,400	55.118	890	35.039	640	25.197	460	18.110	250	9.843	260	10.236	P.57
FT-Z40HBW	1,000	39.370	710	27.953	460	18.110	330	12.992	240	9.449	130	5.118	130	5.118	P.57
FT-Z40W	1,900	74.803	1,300	51.181	900	35.433	630	24.803	460	18.110	240	9.449	260	10.236	P.57
FT-Z802Y	3,500	137.795	3,500	137.795	3,000	118.110	1,500	59.055	1,000	39.370	500	19.685	530	20.866	P.57

Notes: 1) Please contact our office about the sensing ranges for **FX-301-HS** in H-SP mode.
 2) Note that the sensing range of the free-cut type fiber may be reduced by 20 % max. depending upon how the fiber is cut.
 3) The fiber cable length practically limits the sensing range.

FIBER SENSORS

LASER SENSORS

PHOTO-ELECTRIC SENSORS

MICRO PHOTO-ELECTRIC SENSORS

AREA SENSORS

LIGHT CURTAINS / SAFETY COMPONENTS

PRESSURE / FLOW SENSORS

INDUCTIVE PROXIMITY SENSORS

PARTICULAR USE SENSORS

SENSOR OPTIONS

SIMPLE WIRE-SAVING UNITS

WIRE-SAVING SYSTEMS

MEASUREMENT SENSORS

STATIC ELECTRICITY PREVENTION DEVICES

LASER MARKERS

PLC

HUMAN MACHINE INTERFACES

ENERGY CONSUMPTION VISUALIZATION COMPONENTS

FA COMPONENTS

MACHINE VISION SYSTEMS

UV CURING SYSTEMS

Selection Guide

Fibers

Fiber Amplifiers

FX-500

FX-100

FX-300

FX-410

FX-311

FX-301-F7/ FX-301-F

LIST OF FIBERS

FIBER SENSORS

LASER SENSORS

PHOTO-ELECTRIC SENSORS

MICRO PHOTO-ELECTRIC SENSORS

AREA SENSORS

LIGHT CURTAINS/SAFETY COMPONENTS

PRESSURE / FLOW SENSORS

INDUCTIVE PROXIMITY SENSORS

PARTICULAR USE SENSORS

SENSOR OPTIONS

SIMPLE WIRE-SAVING UNITS

WIRE-SAVING SYSTEMS

MEASUREMENT SENSORS

STATIC ELECTRICITY PREVENTION DEVICES

LASER MARKERS

PLC

HUMAN MACHINE INTERFACES

ENERGY CONSUMPTION VISUALIZATION COMPONENTS

FA COMPONENTS

MACHINE VISION SYSTEMS

UV CURING SYSTEMS

FX-301 / FX-305 (Red LED type) sensing range (Note 1)

Retroreflective type

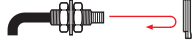

The **FX-305** and **FX-301(-HS)** have different sensing modes.
FX-305: H-SP, FAST, STD, STDF, LONG, U-LG (no S-D mode)
FX-301(-HS): S-D, H-SP (Note 1), FAST, STD, LONG (no STDF or U-LG mode)

Fibers are listed in alphabetic order. Refer to p.5~ "Fiber Selection" for details of each fiber.

Model No.	Sensing range (mm in) (Note 2, 3)								Dimensions
	Red LED								
	U-LG	LONG	STDF	STD	FAST	H-SP	S-D		
FR-KZ22E	15 to 370 0.591 to 14.567	15 to 330 0.591 to 12.992	15 to 240 0.591 to 9.449	15 to 210 0.591 to 8.268	15 to 170 0.590 to 6.693	15 to 80 0.591 to 3.150	15 to 90 0.591 to 3.543	P.58	
FR-KZ50E	20 to 350 0.787 to 13.780	20 to 300 0.787 to 11.811	20 to 250 0.787 to 9.843	20 to 200 0.787 to 7.874	20 to 200 0.787 to 7.874	20 to 200 0.787 to 7.874	20 to 200 0.787 to 7.874	P.58	
FR-KZ50H	20 to 350 0.787 to 13.780	20 to 300 0.787 to 11.811	20 to 250 0.787 to 9.843	20 to 200 0.787 to 7.874	20 to 200 0.787 to 7.874	20 to 200 0.787 to 7.874	20 to 200 0.787 to 7.874	P.58	
FR-Z50HW	100 to 920 3.937 to 36.220	100 to 810 3.937 to 31.890	100 to 660 3.937 to 25.984	100 to 580 3.937 to 22.835	100 to 490 3.937 to 19.291	100 to 340 3.937 to 13.385	100 to 270 3.937 to 10.630	P.58	

- Notes: 1) Please contact our office about the sensing ranges for **FX-301-HS** in H-SP mode.
 2) Note that the sensing range of the free-cut type fiber may be reduced by 20 % max. depending upon how the fiber is cut.
 The sensing range of **FR-KZ22E** is specified for the attached reflector. The sensing range of **FR-KZ50E** and **FR-KZ50H** is specified for the attached reflector **RF-003**. The sensing range of **FR-Z50HW** is specified for the **RF-13**.
 3) The sensing range is the possible setting range for the attached reflector. The fiber can detect an object less than setting range for the reflector. However, note that if there are any white or highly-reflective surfaces near the fiber head, reflected incident light may affect the fiber head. If this occurs, adjust the threshold value of the amplifier unit before use.

Sensing range when using in combination with FR-Z50HW reflector (Optional)

The sensing ranges are the value for red LED types.

Reflector Model No.	Sensing range (mm in)							
	FX-301 / 305							FX-301-HS
	U-LG	LONG	STDF	STD	FAST	S-D	H-SP	H-SP
RF-230	100 to 7,500 3.937 to 295.276	100 to 3,200 3.937 to 125.984	100 to 2,900 3.937 to 114.173	100 to 2,000 3.937 to 78.740	100 to 1,600 3.937 to 62.992	100 to 1,000 3.937 to 39.370	100 to 900 3.937 to 35.433	100 to 700 3.937 to 27.559
RF-220	100 to 2,400 3.937 to 94.488	100 to 2,400 3.937 to 94.488	100 to 1,900 3.937 to 74.803	100 to 1,300 3.937 to 51.181	100 to 1,000 3.937 to 39.370	100 to 600 3.937 to 23.622	100 to 570 3.937 to 22.441	100 to 350 3.937 to 13.780
RF-210	100 to 2,100 3.937 to 82.677	100 to 1,700 3.937 to 66.929	100 to 1,300 3.937 to 51.181	100 to 910 3.937 to 35.827	100 to 710 3.937 to 27.953	100 to 460 3.937 to 18.110	100 to 440 3.937 to 17.323	—————

Note: The sensing range is the possible setting range for the reflector. The fiber can detect an object less than setting range for the reflector. However, note that if there are any white or highly-reflective surfaces near the fiber head, reflected incident light may affect the fiber head. If this occurs, adjust the threshold value of the amplifier unit before use.

FX-301 / FX-305 (Red LED type) sensing range (Note 1)

Reflective type



The **FX-305** and **FX-301(-HS)** have different sensing modes.
FX-305: H-SP, FAST, STD, STDF, LONG, U-LG (no S-D mode)
FX-301(-HS): S-D, H-SP (Note 1), FAST, STD, LONG (no STDF or U-LG mode)

Fibers are listed in alphabetic order. Refer to p.5~ "Fiber Selection" for details of each fiber.

Model No.	Sensing range (mm in) (Note 2, 3) / Description											Dimensions
	Red LED											
	U-LG	LONG	STDF	STD	FAST	H-SP	S-D					
FD-30	170 6.693	110 4.331	70 2.756	50 1.969	40 1.575	20 0.787	18 0.709	P.59				
FD-31	150 5.906	95 3.740	63 2.480	45 1.772	35 1.378	17 0.669	16 0.630	P.59				
FD-31W	60 2.362	40 1.575	30 1.181	20 0.787	15 0.591	8 0.315	10 0.394	P.59				
FD-32G	210 8.268	120 4.724	100 3.937	60 2.362	42 1.654	20 0.787	20 0.787	P.59				
FX-500	FD-32GX	240 9.449	140 5.512	100 3.937	70 2.756	50 1.969	25 0.984	25 0.984	P.59			
FX-100	FD-40	170 6.693	110 4.331	70 2.756	50 1.969	40 1.575	20 0.787	18 0.709	P.59			
FX-300	FD-41	150 5.906	95 3.740	63 2.480	45 1.772	35 1.378	17 0.669	16 0.630	P.59			
FX-410	FD-41S	150 5.906	95 3.740	63 2.480	45 1.772	35 1.378	17 0.669	16 0.630	P.59			
FX-311	FD-41SW	60 2.362	40 1.575	30 1.181	20 0.787	15 0.591	8 0.315	10 0.394	P.59			
FX-301-F7/ FX-301-F	FD-41W	300 11.811	220 8.661	140 5.512	95 3.740	70 2.756	35 1.378	40 1.575	P.59			
	FD-42G	210 8.268	120 4.724	100 3.937	60 2.362	42 1.654	20 0.787	20 0.787	P.60			
	FD-42GW	160 6.299	85 3.346	70 2.756	35 1.378	25 0.984	13 0.512	14 0.551	P.60			
	FD-60	500 19.685	350 13.780	240 9.449	160 6.299	130 5.118	70 2.756	70 2.756	P.60			
	FD-61	440 17.323	320 12.598	205 8.071	145 5.709	105 4.134	65 2.559	60 2.362	P.60			
	FD-61G	460 18.110	200 7.874	210 8.268	90 3.543	65 2.559	35 1.378	40 1.575	P.60			
	FD-61S	440 17.323	320 12.598	205 8.071	145 5.709	105 4.134	60 2.362	60 2.362	P.60			

- Notes: 1) Please contact our office about the sensing ranges for **FX-301-HS** in H-SP mode.
 2) Note that the sensing range of the free-cut type fiber may be reduced by 20 % max. depending upon how the fiber is cut.
 3) The sensing range is specified for white non-glossy paper.

LIST OF FIBERS

FX-301 / FX-305 (Red LED type) sensing range (Note 1)

Reflective type



The **FX-305** and **FX-301(-HS)** have different sensing modes.
FX-305: H-SP, FAST, STD, STDF, LONG, U-LG (no S-D mode)
FX-301(-HS): S-D, H-SP (Note 1), FAST, STD, LONG (no STDF or U-LG mode)

Fibers are listed in alphabetic order. Refer to p.5~ "Fiber Selection" for details of each fiber.

Model No.	Sensing range (mm in) (Note 2, 3) / Description										Dimensions
	Red LED										
	U-LG	LONG	STDF	STD	FAST	H-SP	S-D				
FD-61W	300 11.811	220 8.661	140 5.512	95 3.740	70 2.756	35 1.378	40 1.575				P.60
FD-62	690 27.165	480 18.898	310 12.205	220 8.661	160 6.299	85 3.346	90 3.543				P.60
FD-64X	270 10.630	200 7.874	100 3.937	85 3.346	60 2.362	35 1.378	35 1.378				P.61
FD-A16	230 9.055	200 7.874	150 5.906	150 5.906	100 3.937	45 1.772	50 1.969				P.61
FD-AL11	360 14.173	250 9.843	160 6.299	110 4.331	80 3.150	40 1.575	40 1.575				P.61
FD-E13	15 0.591	11 0.433	7 0.276	6 0.236	4 0.157	2 0.079	2 0.079				P.61
FD-E23	65 2.559	45 1.772	28 1.102	19 0.748	14 0.551	7 0.276	7 0.276				P.61
FD-EG30	60 2.362	45 1.772	25 0.984	19 0.748	14 0.551	7 0.276	7 0.276				P.61
FD-EG30S	60 2.362	45 1.772	25 0.984	19 0.748	14 0.551	7 0.276	7 0.276				P.62
FD-EG31	20 0.787	15 0.591	9 0.354	8 0.315	5 0.197	2.5 0.098	3 0.118				P.62
FD-F4	Applicable pipe diameter: Outer dia. $\phi 6$ to $\phi 26$ mm $\phi 0.236$ to $\phi 1.024$ in transparent pipe [PFA (fluorine resin) or equivalently transparent pipe, wall thickness 1 mm 0.039 in]										P.62
FD-F41	Applicable pipe diameter: Outer dia. $\phi 6$ to $\phi 26$ mm $\phi 0.236$ to $\phi 1.024$ in transparent pipe [PVC (vinyl chloride), fluorine resin, polycarbonate, acrylic, glass, wall thickness 1 to 3 mm 0.039 to 0.118 in]										P.62
FD-F41Y	$\phi 4$ mm $\phi 0.157$ in form Protective tube: fluorine resin, length 500 mm 19.685 in (cuttable) Liquid surface not contacted: Beam received, Liquid surface contacted: Beam interrupted										P.62
FD-F8Y	—————										P.62
FD-FA93	Applicable pipe diameter: Outer dia. $\phi 8$ mm $\phi 0.315$ in or more transparent pipe (When used with the tying bands: $\phi 8$ to $\phi 80$ mm $\phi 0.315$ to $\phi 3.150$ in) [PFA (fluorine resin), including translucent] Liquid absent: Beam received, Liquid present: Beam interrupted										P.62
FD-H13-FM2	410 16.142	310 12.205	200 7.874	140 5.512	100 3.937	55 2.165	47 1.850				P.63
FD-H18-L31	0 to 20 0 to 0.787	0 to 15 0 to 0.591	0 to 10 0 to 0.394	0 to 10 0 to 0.394	1 to 8 0.039 to 0.315	Cannot use	2 to 6 0.079 to 0.236				P.63
FD-H20-21	300 11.811	270 10.630	150 5.906	140 5.512	100 3.937	35 1.378	47 1.850				P.63
FD-H20-M1	300 11.811	270 10.630	150 5.906	140 5.512	100 3.937	35 1.378	47 1.850				P.63
FD-H25-L43 (Note 5)	3 to 28 0.118 to 1.102	3 to 25 0.118 to 0.984	4 to 23 0.157 to 0.906	4 to 20 0.118 to 0.787	4 to 19 0.118 to 0.748	4 to 16 0.118 to 0.630	4 to 16 0.118 to 0.630				P.63
FD-H25-L45 (Note 5)	5 to 42 0.197 to 1.654	6 to 41 0.236 to 1.614	6 to 40 0.236 to 1.575	7 to 38 0.276 to 1.496	—————	—————	—————				P.63
FD-H30-KZ1V-S (Note 5,6)	20 to 300 0.787 to 11.811	20 to 200 0.787 to 7.874	20 to 150 0.787 to 5.906	25 to 130 0.984 to 5.118	30 to 100 1.181 to 3.937	Cannot use	Cannot use				P.64
FD-H30-L32	0 to 20 0 to 0.787	0 to 15 0 to 0.591	0 to 10 0 to 0.394	0 to 10 0 to 0.394	1 to 8 0.039 to 0.315	Cannot use	2 to 6 0.079 to 0.236				P.64
FD-H30-L32V-S (Note 5,6)	0 to 11 0 to 0.433	0 to 8 0 to 0.315	1.5 to 6 0.059 to 0.236	1.5 to 5 0.059 to 0.197	2 to 4 0.079 to 0.157	Cannot use	Cannot use				P.64
FD-H35-20S	190 7.480	160 6.299	80 3.150	80 3.150	57 2.244	20 0.787	26 1.024				P.64
FD-H35-M2	300 11.811	270 10.630	150 5.906	140 5.512	100 3.937	35 1.378	47 1.850				P.64
FD-H35-M2S6	300 11.811	270 10.630	150 5.906	140 5.512	100 3.937	35 1.378	47 1.850				P.64
FD-HF40Y (Note 4)	$\phi 4$ mm $\phi 0.157$ in form Protective tube: fluorine resin, length:500 mm 19.685 in (allowable cutting) Liquid surface not contacted: Beam received, Liquid surface contacted: Beam interrupted										P.64
FD-L10 (Note 5)	0 to 4.7 0 to 0.185	0 to 4.5 0 to 0.177	0 to 4.5 0 to 0.177	0 to 4 0 to 0.157	0 to 3.8 0 to 0.150	0 to 3.5 0 to 0.138	0 to 3.5 0 to 0.138				P.65
FD-L11 (Note 5)	0 to 9 0 to 0.354	0 to 8 0 to 0.315	0 to 8 0 to 0.315	0 to 7 0 to 0.906	0 to 7 0 to 0.276	0 to 6 0 to 0.236	0 to 6 0 to 0.236				P.65
FD-L12W (Note 5)	0.5 to 9 0.020 to 0.354	0.5 to 8 0.019 to 0.315	1 to 6.5 0.039 to 0.256	1 to 5.5 0.039 to 0.217	1 to 5 0.039 to 0.197	—————	—————				P.65
FD-L20H	1 to 29 0.039 to 1.142	2 to 23 0.079 to 0.906	3 to 17 0.118 to 0.669	4 to 14 0.157 to 0.551	4.5 to 11 0.177 to 0.433	5 to 8.5 0.196 to 0.335	4.8 to 9.5 0.188 to 0.374				P.65
FD-L21 (Note 5)	2 to 19 0.079 to 0.748	2 to 18 0.079 to 0.709	2 to 16 0.079 to 0.748	3 to 16 0.118 to 0.630	3 to 15 0.118 to 0.591	4 to 11 0.157 to 0.433	5 to 11 0.197 to 0.433				P.65
FD-L21W (Note 5)	3 to 14.5 0.118 to 0.571	3 to 14 0.118 to 0.551	4 to 14 0.157 to 0.551	6 to 12 0.236 to 0.472	7 to 12 0.276 to 0.472	—————	—————				P.65
FD-L22A (Note 5)	0 to 26 0 to 1.024	0 to 23 0 to 0.906	0 to 23 0 to 0.906	0 to 23 0 to 0.906	0 to 19 0 to 0.748	1 to 17 0.039 to 0.669	1 to 17 0.039 to 0.669				P.65

- Notes: 1) Please contact our office about the sensing ranges for **FX-301-HS** in H-SP mode.
 2) Note that the sensing range of the free-cut type fiber may be reduced by 20 % max. depending upon how the fiber is cut.
 3) The sensing range of reflective type is the value for white non-glossy paper (as for **FD-H30-L32** and **FD-H18-L31** 50 × 50 mm 1.969 × 1.969 in glass substrate).
 4) Liquid inflow prevention joint, protective tube extension joint, fiber mounting joint are available. Please refer to p.38 for details.
 5) The sensing range is specified for transparent glass 100 × 100 × 0.7 mm 3.937 × 3.937 × 0.028 in (**FD-L21** and **FD-L21W**: t2 mm 0.079 in) [**FD-L10**: silicon wafers 100 × 100 mm 3.937 × 3.937 in].
 6) Sold as a set comprising vacuum type fiber + photo-terminal (**FV-BR1**) + fiber at atmospheric side (**FT-J8**).

FIBER SENSORS

LASER SENSORS

PHOTO-ELECTRIC SENSORS

MICRO PHOTO-ELECTRIC SENSORS

AREA SENSORS

LIGHT CURTAINS / SAFETY COMPONENTS

PRESSURE / FLOW SENSORS

INDUCTIVE PROXIMITY SENSORS

PARTICULAR USE SENSORS

SENSOR OPTIONS

SMALL WIRE-SAVING UNITS

WIRE-SAVING SYSTEMS

MEASUREMENT SENSORS

STATIC ELECTRICITY PREVENTION DEVICES

LASER MARKERS

PLC

HUMAN MACHINE INTERFACES

ENERGY CONSUMPTION VISUALIZATION COMPONENTS

FA COMPONENTS

MACHINE VISION SYSTEMS

UV CURING SYSTEMS

Selection Guide

Fibers

Fiber Amplifiers

FX-500

FX-100

FX-300

FX-410

FX-311

FX-301-F7/
FX-301-F

LIST OF FIBERS

FX-301 / FX-305 (Red LED type) sensing range (Note 1)

Reflective type



The **FX-305** and **FX-301(-HS)** have different sensing modes.
FX-305: H-SP, FAST, STD, STDF, LONG, U-LG (no S-D mode)
FX-301(-HS): S-D, H-SP (Note 1), FAST, STD, LONG (no STDF or U-LG mode)

Fibers are listed in alphabetic order. Refer to p.5~ "Fiber Selection" for details of each fiber.

Model No.	Sensing range (mm in) (Note 2, 3) / Description								Dimensions
	Red LED								
	U-LG	LONG	STDF	STD	FAST	H-SP	S-D		
FD-L23 (Note 4)	0 to 30 0 to 1.181	0 to 30 0 to 1.181	0 to 30 0 to 1.181	0 to 30 0.039 to 1.181	1 to 28 0.039 to 1.102	2 to 27 0.079 to 1.063	2 to 27 0.079 to 1.063	P.65	
FD-L30A (Note 4)	0 to 50 0 to 1.969	0 to 43 0 to 17.441	0 to 40 0 to 1.575	0 to 37 0 to 1.457	0 to 32 0 to 1.260	0 to 26 0 to 1.024	0 to 26 0 to 1.024	P.65	
FD-L31A (Note 4)	4 to 33 0 to 13.110	4 to 33 0.157 to 1.299	5 to 32 0 to 1.260	5 to 32 0.197 to 1.260	5 to 32 0.197 to 1.259	6 to 18 0.236 to 0.709	6 to 18 0.236 to 0.709	P.65	
FD-L32H (Note 4)	0 to 60 0 to 2.362	0 to 50 0 to 1.969	0 to 36 0 to 0.984	15 to 35 0.591 to 1.378	16 to 29 0.630 to 1.142	—	—	P.66	
FD-R31G	160 6.299	92 3.622	75 2.953	44 1.732	32 1.260	17 0.669	17 0.669	P.66	
FD-R32EG	60 2.362	45 1.772	25 0.984	19 0.748	13 0.512	7 0.276	7 0.276	P.66	
FD-R33EG	17 0.669	15 0.591	8 0.315	6 0.236	4 0.157	2 0.079	2 0.079	P.66	
FD-R34EG	51 2.008	38 1.496	21 0.827	16 0.630	11 0.433	6 0.236	6 0.236	P.66	
FD-R41	230 9.055	150 5.906	100 3.937	70 2.756	50 1.969	28 1.102	28 1.102	P.66	
FD-R60	310 12.205	240 9.449	170 6.693	120 4.724	90 3.543	45 1.772	45 1.772	P.66	
FD-R61Y	350 13.780	230 9.055	160 6.299	110 4.330	80 3.150	45 1.772	45 1.772	P.66	
FD-S21	80 3.150	50 1.969	40 1.575	25 0.984	19 0.748	9 0.354	9 0.354	P.66	
FD-S30	170 6.693	110 4.331	70 2.756	50 1.969	40 1.575	20 0.787	18 0.709	P.67	
FD-S31	150 5.906	95 3.740	63 2.480	45 1.772	35 1.378	17 0.669	16 0.630	P.67	
FD-S32	440 17.323	270 10.630	200 7.874	140 5.512	100 3.937	55 2.165	55 2.165	P.67	
FD-S32W	300 11.811	220 8.661	140 5.512	95 3.740	70 2.756	35 1.378	40 1.575	P.67	
FD-S33GW	160 6.299	85 3.346	70 2.756	35 1.378	25 0.984	13 0.512	14 0.551	P.67	
FD-S60Y	410 16.142	360 14.173	250 9.843	170 6.693	120 4.724	65 2.559	70 2.756	P.67	
FD-V30	80 3.150	45 1.772	30 1.181	20 0.787	15 0.591	6 0.236	7 0.276	P.67	
FD-V30W	25 0.984	15 0.591	10 0.394	7 0.276	5 0.197	—	—	P.67	
FD-V50	170 6.693	100 3.937	55 2.165	45 1.772	32 1.260	15 0.591	16 0.630	P.68	
FD-Z20HBW	1 to 70 0.039 to 2.756	1 to 70 0.039 to 2.756	1 to 32.2 0.039 to 1.268	2 to 30 0.079 to 1.181	2.5 to 20 0.098 to 0.787	3 to 10 0.118 to 0.394	3 to 10 0.118 to 0.394	P.68	
FD-Z20W	1 to 87 0.039 to 3.425	1 to 59 0.09 to 2.323	2 to 39 0.079 to 1.535	3 to 27 0.118 to 1.063	3 to 19 0.118 to 0.748	—	—	P.68	
FD-Z40HBW	350 13.780	0.5 to 230 0.02 to 9.055	1 to 160 0.039 to 6.299	1 to 100 0.039 to 3.937	1 to 70 0.039 to 2.756	1 to 40 0.039 to 1.575	1 to 40 0.039 to 1.575	P.68	
FD-Z40W	270 10.630	180 7.087	120 4.724	1 to 87 0.039 to 3.425	1 to 63 0.039 to 2.480	2.5 to 32 0.098 to 1.260	2.5 to 32 0.098 to 1.260	P.68	
FD-Z50HW	10 to 870 0.394 to 34.252	10 to 540 0.394 to 21.260	10 to 400 0.394 to 15.748	10 to 250 0.393 to 9.843	10 to 190 0.394 to 7.480	15 to 100 0.196 to 3.937	15 to 100 0.591 to 3.937	P.68	

- Notes: 1) Please contact our office about the sensing ranges for **FX-301-HS** in H-SP mode.
 2) Note that the sensing range of the free-cut type fiber may be reduced by 20 % max. depending upon how the fiber is cut.
 3) The sensing range of reflective type is the value for white non-glossy paper.
 4) The sensing range is specified for transparent glass 100 × 100 × t0.7 mm 3.937 × 3.937 × t0.028 in (**FD-L32H**: R edge).

SENSING RANGE OF BLUE LED / GREEN LED / INFRARED LED

Thru-beam type (One pair set) 

Fibers are listed in alphabetic order. Refer to p.5~ for details of each fiber.

Model No.	Sensing range (mm in) (Note 1)									Dimensions
	FX-301B / 311B			FX-301G / 311G			FX-301H (Note 2)			
	LONG	STD	FAST	LONG	STD	FAST	LONG	STD	FAST	
FT-140	8,100 318.898	4,000 157.480	3,100 122.047	5,000 196.850	2,400 94.488	1,600 62.992	3,700 145.669	2,000 78.740	1,400 55.118	P.51
FT-30	55 2.165	28 1.102	18 0.709	28 1.102	13 0.512	9 0.354	25 0.984	13 0.512	9 0.354	P.51
FT-31	50 1.969	25 0.984	16 0.630	24 0.945	12 0.472	8 0.315	23 0.906	11 0.433	8 0.315	P.51
FT-31S	50 1.969	25 0.984	16 0.630	24 0.945	12 0.472	8 0.315	23 0.906	11 0.433	8 0.315	P.51
FT-31W	31 1.220	15 0.591	10 0.394	15 0.591	8 0.315	5 0.197	18 0.709	8 0.315	5 0.197	P.51
FT-40	155 6.102	76 2.992	45 1.772	90 3.543	40 1.575	26 1.024	80 3.150	43 1.693	27 1.063	P.51
FT-42	150 5.906	75 2.953	40 1.575	80 3.150	35 1.378	24 0.945	75 2.953	40 1.575	25 0.984	P.51
FT-42S	150 5.906	75 2.953	40 1.575	70 2.756	35 1.378	24 0.945	75 2.953	40 1.575	25 0.984	P.51
FT-42W	110 4.331	50 1.969	30 1.181	56 2.205	28 1.102	20 0.787	64 2.520	32 1.260	21 0.827	P.51
FT-43	220 8.661	110 4.331	75 2.953	120 4.724	61 2.402	43 1.693	140 5.512	74 2.913	48 1.890	P.51
FT-45X	130 5.118	65 2.559	45 1.772	70 2.756	34 1.339	25 0.984	160 6.299	79 3.110	53 2.087	P.52
FT-A11	880 34.646	420 16.535	270 10.630	430 16.929	220 8.661	120 4.724	500 19.685	220 8.661	120 4.724	P.52
FT-A11W	820 32.283	420 16.535	280 11.024	460 18.110	220 8.661	140 5.512	520 20.472	240 9.449	140 5.512	P.52
FT-A32	1,800 70.866	710 27.953	400 15.748	970 38.189	320 12.598	180 7.087	910 35.827	340 13.386	150 5.906	P.52
FT-A32W	2,000 78.740	830 32.677	420 16.535	1,000 39.370	350 13.780	180 7.087	910 35.827	340 13.386	150 5.906	P.52
FT-AL05	100 3.937	48 1.890	32 1.260	56 2.205	27 1.063	18 0.709	54 2.126	27 1.063	18 0.709	P.52
FT-E13	2 0.079	1 0.039	—	1 0.039	—	—	2 0.079	1 0.039	—	P.52
FT-E23	8 0.315	4 0.157	3 0.118	4 0.157	2 0.079	1 0.039	10 0.394	5 0.197	3 0.118	P.52
FT-H13-FM2	72 2.835	36 1.417	26 1.024	32 1.260	16 0.630	10 0.394	70 2.756	35 1.378	25 0.984	P.52
FT-H20-J20-S (Note 3)	60 2.362	20 0.787	—	35 1.378	—	—	20 0.787	—	—	P.53
FT-H20-J30-S (Note 3)	60 2.362	20 0.787	—	35 1.378	—	—	20 0.787	—	—	P.53
FT-H20-J50-S (Note 3)	60 2.362	20 0.787	—	35 1.378	—	—	20 0.787	—	—	P.53
FT-H20-M1	100 3.937	50 1.969	35 1.378	50 1.969	25 0.984	18 0.709	550 21.654	280 11.024	160 6.299	P.53
FT-H20-VJ50-S (Note 3)	85 3.346	30 1.181	—	50 1.969	—	—	30 1.181	—	—	P.53
FT-H20-VJ80-S (Note 3)	85 3.346	30 1.181	—	50 1.969	—	—	30 1.181	—	—	P.53
FT-H20W-M1	44 1.732	22 0.866	14 0.551	22 0.866	11 0.433	7 0.276	220 8.661	100 3.937	70 2.756	P.53
FT-H30-M1V-S (Note 4)	40 1.575	20 0.787	—	20 0.787	—	—	20 0.787	—	—	P.53
FT-H35-M2	100 3.937	50 1.969	35 1.378	50 1.969	25 0.984	18 0.709	550 21.654	280 11.024	160 6.299	P.53
FT-H35-M2S6	100 3.937	50 1.969	35 1.378	50 1.969	25 0.984	18 0.709	550 21.654	280 11.024	160 6.299	P.53
FT-HL80Y	80 3.150	40 1.575	25 0.984	110 4.331	55 2.165	40 1.575	1,100 43.307	550 21.654	350 13.780	P.53
FT-KS40	740 29.134	280 11.024	220 8.661	420 16.535	180 7.087	81 3.189	460 18.110	190 7.480	95 3.740	P.54
FT-KV26	81 3.189	36 1.417	21 0.827	44 1.732	8 0.315	—	53 2.087	19 0.748	—	P.54
FT-KV40	710 27.953	270 10.630	210 8.268	420 16.535	180 7.087	100 3.937	290 11.417	120 4.724	53 2.087	P.54
FT-KV40W	860 33.858	400 15.748	260 10.236	420 16.535	210 8.268	140 5.512	490 19.291	240 9.449	140 5.512	P.54
FT-L80Y	160 6.299	80 3.150	50 1.969	160 6.299	80 3.150	50 1.969	400 15.748	200 7.874	150 5.906	P.54
FT-R31	45 1.772	23 0.906	15 0.591	24 0.945	12 0.472	8 0.315	23 0.906	11 0.433	8 0.315	P.54
FT-R40	110 4.331	54 2.126	36 1.417	55 2.165	26 1.024	20 0.787	58 2.283	30 1.181	20 0.787	P.54
FT-R41W	110 4.331	50 1.969	30 1.181	56 2.205	28 1.102	20 0.787	64 2.520	32 1.260	21 0.827	P.54
FT-R42W	280 11.024	130 5.118	90 3.543	140 5.512	70 2.756	47 1.850	140 5.512	70 2.756	47 1.850	P.54

- Notes: 1) Note that the sensing range of the free-cut type fiber may be reduced by 20 % max. depending upon how the fiber is cut.
 2) Because infrared types are easily affected by humidity, please ask assistance when using them in a humid environment or in an environment with varying humidity.
 3) Heat-resistant joint fibers and ordinary-temperature fibers (FT-42) are sold as a set.
 4) Sold as a set comprising vacuum type fiber + photo-terminal (FV-BR1) + fiber at atmospheric side (FT-J8).

FIBER SENSORS

LASER SENSORS

PHOTO-ELECTRIC SENSORS

MICRO PHOTO-ELECTRIC SENSORS

AREA SENSORS

LIGHT CURTAINS / SAFETY COMPONENTS

PRESSURE / FLOW SENSORS

INDUCTIVE PROXIMITY SENSORS

PARTICULAR USE SENSORS

SENSOR OPTIONS

SMALL WIRE-SAVING UNITS

WIRE-SAVING SYSTEMS

MEASUREMENT SENSORS

STATIC ELECTRICITY PREVENTION DEVICES

LASER MARKERS

PLC

HUMAN MACHINE INTERFACES

ENERGY CONSUMPTION VISUALIZATION COMPONENTS

FA COMPONENTS

MACHINE VISION SYSTEMS

UV CURING SYSTEMS

Selection Guide

Fibers

Fiber Amplifiers

FX-500

FX-100

FX-300

FX-410

FX-311

FX-301-F7/ FX-301-F

SENSING RANGE OF BLUE LED / GREEN LED / INFRARED LED

FIBER SENSORS

LASER SENSORS

PHOTO-ELECTRIC SENSORS

MICRO PHOTO-ELECTRIC SENSORS

AREA SENSORS

LIGHT CURTAINS / SAFETY COMPONENTS

PRESSURE / FLOW SENSORS

INDUCTIVE PROXIMITY SENSORS

PARTICULAR USE SENSORS

SENSOR OPTIONS

SIMPLE WIRE-SAVING UNITS

WIRE-SAVING SYSTEMS

MEASUREMENT SENSORS

STATIC ELECTRICITY PREVENTION DEVICES

LASER MARKERS

PLC

HUMAN MACHINE INTERFACES

ENERGY CONSUMPTION VISUALIZATION COMPONENTS

FA COMPONENTS

MACHINE VISION SYSTEMS

UV CURING SYSTEMS

Selection Guide

Fibers

Fiber Amplifiers

FX-500

FX-100

FX-300

FX-410

FX-311

FX-301-F7/
FX-301-F

Thru-beam type (One pair set)



Fibers are listed in alphabetic order. Refer to p.5~ "Fiber Selection" for details of each fiber.

Model No.	Sensing range (mm in) (Note 1)									Dimensions
	FX-301B / 311B			FX-301G / 311G			FX-301H (Note 2)			
	LONG	STD	FAST	LONG	STD	FAST	LONG	STD	FAST	
FT-R43	96 3.780	50 1.969	33 1.299	53 2.087	25 0.984	17 0.669	55 2.165	27 1.063	18 0.709	P.54
FT-R44Y	96 3.780	50 1.969	33 1.299	53 2.087	25 0.984	17 0.669	55 5.165	27 1.063	18 0.709	P.55
FT-R60Y	250 9.843	120 4.724	80 3.150	140 5.512	70 2.756	50 1.969	60 2.362	90 3.543	170 6.693	P.55
FT-S11	12 0.472	5 0.197	4 0.157	5 0.197	2.5 0.098	1.5 0.059	21 0.827	10 0.394	7 0.276	P.55
FT-S20	55 2.165	28 1.102	18 0.709	28 1.102	13 0.512	9 0.354	25 0.984	13 0.512	9 0.354	P.55
FT-S21	50 1.969	25 0.984	16 0.630	24 0.945	12 0.472	8 0.315	23 0.906	11 0.433	8 0.315	P.55
FT-S21W	31 1.220	15 0.591	10 0.394	15 0.591	8 0.315	5 0.197	18 0.709	8 0.315	5 0.197	P.55
FT-S30	155 6.102	76 2.992	45 1.772	90 3.543	40 1.575	26 1.024	80 3.150	43 1.693	27 1.063	P.55
FT-S31W	110 4.331	50 1.969	30 1.181	56 2.205	28 1.102	20 0.787	64 2.520	32 1.260	21 0.827	P.55
FT-S32	420 16.535	200 7.874	130 5.118	220 8.661	100 3.937	72 2.835	210 8.268	100 3.937	67 2.638	P.55
FT-V23	65 2.559	26 1.024	18 0.709	26 1.024	13 0.512	8 0.315	29 1.142	13 0.512	9 0.354	P.55
FT-V24W	6 0.236	2 0.079	—	3 0.118	—	—	3 0.118	—	—	P.56
FT-V25	25 0.984	12 0.472	9 0.354	16 0.630	7 0.276	5 0.197	15 0.591	8 0.315	4 0.157	P.56
FT-V30	80 3.150	40 1.575	22 0.866	40 1.575	14 0.551	8 0.315	47 1.850	19 0.748	9 0.354	P.56
FT-V40	400 15.748	200 7.874	130 5.118	200 7.874	100 3.937	65 2.559	290 11.417	140 5.512	92 3.622	P.56
FT-V80Y	120 4.724	60 2.362	35 1.378	80 3.150	40 1.575	25 0.984	75 2.953	38 1.496	24 0.945	P.56
FT-Z20HBW	39 1.535	19 0.748	12 0.472	20 0.787	10 0.394	6 0.236	40 1.575	15 0.591	12 0.472	P.56
FT-Z20W	82 3.228	37 1.457	23 0.906	44 1.732	18 0.709	11 0.433	100 3.937	50 1.969	32 1.260	P.56
FT-Z30	120 4.724	60 2.362	40 1.575	96 3.780	45 1.772	30 1.181	140 5.512	72 2.835	47 1.850	P.56
FT-Z30E	540 21.260	250 9.843	170 6.693	270 10.630	130 5.118	91 3.583	280 11.024	140 5.512	88 3.465	P.56
FT-Z30EW	540 21.260	260 10.236	170 6.693	260 10.236	120 4.724	88 3.465	290 11.417	140 5.512	92 3.622	P.57
FT-Z30H	650 25.591	310 12.205	200 7.874	340 13.386	160 6.299	110 4.331	330 12.992	160 6.299	100 3.937	P.57
FT-Z30HW	540 21.260	260 10.236	170 6.693	260 10.236	120 4.724	88 3.465	290 11.417	140 5.512	92 3.622	P.57
FT-Z30W	83 3.268	40 1.575	25 0.984	73 2.874	36 1.417	25 0.984	100 3.937	52 2.047	34 1.339	P.57
FT-Z40HBW	110 4.331	50 1.969	30 1.181	56 2.205	28 1.102	20 0.787	64 2.520	32 1.260	21 0.827	P.57
FT-Z40W	180 7.087	90 3.543	60 2.362	90 3.543	50 1.969	35 1.378	100 3.937	50 1.969	30 1.181	P.57
FT-Z802Y	320 12.598	160 6.299	120 4.724	160 6.299	80 3.150	60 2.362	320 12.598	160 6.299	120 4.724	P.57

Notes: 1) Note that the sensing range of the free-cut type fiber may be reduced by 20 % max. depending upon how the fiber is cut.

2) Because infrared types are easily affected by humidity, please ask assistance when using them in a humid environment or in an environment with varying humidity.

Retroreflective type



Fibers are listed in alphabetic order. Refer to p.5~ "Fiber Selection" for details of each fiber.

Model No.	Sensing range (mm in) (Note 1, 2)									Dimensions
	FX-301B / 311B			FX-301G / 311G			FX-301H			
	LONG	STD	FAST	LONG	STD	FAST	LONG	STD	FAST	
FR-KZ22E	—	—	—	—	—	—	—	—	—	P.58
FR-KZ50E	20 to 160 0.787 to 6.299	20 to 100 0.787 to 3.937	20 to 60 0.787 to 2.362	20 to 110 0.787 to 4.331	20 to 54 0.787 to 2.126	—	20 to 100 0.787 to 3.937	20 to 33 0.787 to 1.299	—	P.58
FR-KZ50H	20 to 140 0.787 to 5.512	20 to 70 0.787 to 2.76	20 to 52 0.787 to 2.047	20 to 90 0.787 to 3.543	20 to 40 0.787 to 1.575	—	20 to 80 0.787 to 3.150	20 to 43 0.787 to 1.693	—	P.58
FR-Z50HW	—	—	—	—	—	—	100 to 410 3.937 to 16.142	—	—	P.58

Notes: 1) Note that the sensing range of the free-cut type fiber may be reduced by 20 % max. depending upon how the fiber is cut.

2) The sensing range is the possible setting range for the attached reflector. The fiber can detect an object less than setting range for the reflector.

However, note that if there are any white or highly-reflective surfaces near the fiber head, reflected incident light may affect the fiber head. If this occurs, adjust the threshold value of the amplifier unit before use.

SENSING RANGE OF BLUE LED / GREEN LED / INFRARED LED

Reflective type 

Fibers are listed in alphabetic order. Refer to p.5~ "Fiber Selection" for details of each fiber.

Model No.	Sensing range (mm in) (Note 1, 2) / Description									Dimensions
	FX-301B / 311B			FX-301G / 311G			FX-301H			
	LONG	STD	FAST	LONG	STD	FAST	LONG	STD	FAST	
FD-30	19 0.748	9 0.354	6 0.236	9 0.354	4.5 0.177	2.5 0.098	8 0.315	4 0.157	2.5 0.098	P.59
FD-31	18 0.709	8 0.315	5 0.197	8 0.315	4 0.157	2 0.079	7 0.276	3 0.118	2 0.079	P.59
FD-31W	7 0.276	4 0.157	1 to 2.5 0.039 to 0.098	5 0.197	1 to 2 0.039 to 0.079	—	6 0.236	3 0.118	—	P.59
FD-32G	22 0.866	11 0.433	8 0.315	15 0.591	6 0.236	4 0.157	11 0.433	6 0.236	2 0.079	P.59
FD-32GX	25 0.984	11 0.433	8 0.315	16 0.630	6 0.236	4 0.157	14 0.551	7 0.276	4 0.157	P.59
FD-40	19 0.748	9 0.354	6 0.236	9 0.354	4.5 0.177	2.5 0.098	8 0.315	4 0.157	2.5 0.098	P.59
FD-41	18 0.709	8 0.315	5 0.197	8 0.315	4 0.157	2 0.079	7 0.276	3 0.118	2 0.079	P.59
FD-41S	18 0.709	8 0.315	5 0.197	8 0.315	4 0.157	2 0.079	7 0.276	3 0.118	2 0.079	P.59
FD-41SW	9 0.354	1 to 4 0.039 to 0.157	1 to 2.5 0.039 to 0.098	1 to 4 0.039 to 0.157	1 to 2 0.039 to 0.079	—	6 0.236	1 to 3 0.039 to 0.118	—	P.59
FD-41W	32 1.260	1 to 15 0.039 to 0.591	1 to 9 0.039 to 0.354	17 0.669	1 to 7.5 0.039 to 0.295	1.5 to 4.5 0.059 to 0.177	18 0.709	1 to 9 0.039 to 0.354	1.5 to 5 0.059 to 0.197	P.59
FD-42G	22 0.866	11 0.433	8 0.315	15 0.591	6 0.236	4 0.157	11 0.433	6 0.236	2 0.079	P.60
FD-42GW	14 0.551	7 0.276	5 0.197	6 0.236	4 0.157	2 0.079	9 0.354	5 0.197	2 0.079	P.60
FD-60	55 2.165	28 1.102	18 0.709	30 1.181	15 0.591	10 0.394	30 1.181	15 0.591	10 0.394	P.60
FD-61	48 1.890	24 0.945	16 0.630	26 1.024	13 0.512	8 0.315	27 1.063	12 0.472	8 0.315	P.60
FD-61G	46 1.811	23 0.906	15 0.591	26 1.024	12 0.472	8 0.315	25 0.984	12 0.472	8 0.315	P.60
FD-61S	48 1.890	24 0.945	16 0.630	26 1.024	13 0.512	8 0.315	27 1.063	12 0.472	8 0.315	P.60
FD-61W	32 1.260	1 to 15 0.039 to 0.591	1 to 9 0.039 to 0.354	17 0.669	1 to 7.5 0.039 to 0.295	1.5 to 4.5 0.059 to 0.177	18 0.709	1 to 9 0.039 to 0.354	1.5 to 5 0.059 to 0.197	P.60
FD-62	80 3.150	1 to 40 0.039 to 1.575	1 to 27 0.039 to 1.063	1 to 42 0.039 to 1.654	1 to 21 0.039 to 0.827	1 to 14 0.039 to 0.551	54 2.126	1 to 26 0.039 to 1.024	1 to 17 0.039 to 0.669	P.60
FD-64X	32 1.260	0.5 to 16 0.020 to 0.630	0.5 to 10 0.020 to 0.394	0.5 to 16 0.020 to 0.630	0.5 to 8 0.020 to 0.315	0.5 to 5 0.020 to 0.197	27 1.063	22 0.866	14 0.551	P.61
FD-A16	19 0.748	14 0.551	—	20 0.787	13 0.512	—	18 0.709	15 0.591	—	P.61
FD-AL11	33 1.299	16 0.630	10 0.394	18 0.709	8 0.315	4.5 0.177	12 0.472	10 0.394	6 0.236	P.61
FD-E13	2 0.079	0.8 0.031	0.5 0.020	0.8 0.031	—	—	2 0.079	1 0.039	—	P.61
FD-E23	6 0.236	3 0.118	2 0.079	3 0.118	1.5 0.059	1 0.039	8 0.315	4 0.157	2.5 0.098	P.61
FD-EG30	6 0.236	3 0.118	2 0.079	3 0.118	1.5 0.059	1 0.039	8 0.315	4 0.157	2.5 0.098	P.61
FD-EG30S	6 0.236	3 0.118	2 0.079	3 0.118	1.5 0.059	1 0.039	8 0.315	4 0.157	2.5 0.098	P.62
FD-EG31	2 0.079	1 0.039	0.5 0.020	1 0.039	—	—	4 0.157	2 0.079	1 0.039	P.62
FD-F4	Applicable pipe diameter: Outer dia. $\phi 6$ to $\phi 26$ mm $\phi 0.236$ to $\phi 1.024$ in transparent pipe [PFA (fluorine resin) or equivalently transparent pipe, wall thickness 1 mm 0.039 in] Liquid absent: Beam received, Liquid present: Beam interrupted									P.62
FD-F41	Applicable pipe diameter: Outer dia. $\phi 6$ to $\phi 26$ mm $\phi 0.236$ to $\phi 1.024$ in transparent pipe [PVC (vinyl chloride), fluorine resin, polycarbonate, acrylic, glass, wall thickness 1 to 3 mm 0.039 to 0.118 in] Liquid absent: Beam received, Liquid present: Beam interrupted									P.62
FD-F41Y (Note 3)	$\phi 4$ mm $\phi 0.157$ in form Protective tube: fluorine resin, length 500 mm 19.685 in (cuttable) Liquid surface not contacted: Beam received, Liquid surface contacted: Beam interrupted									P.62
FD-F8Y	—									P.62
FD-FA93	Applicable pipe diameter: Outer dia. $\phi 8$ mm $\phi 0.315$ in or more transparent pipe (When used with the tying bands: $\phi 8$ to $\phi 80$ mm $\phi 0.315$ to $\phi 3.150$ in) [PFA (fluorine resin), including translucent] Liquid absent: Beam received, Liquid present: Beam interrupted									P.62
FD-H13-FM2	20 0.787	11 0.433	7 0.276	20 0.787	11 0.433	7 0.276	25 0.984	12 0.472	8 0.315	P.63
FD-H18-L31	—									P.63
FD-H20-21	36 1.417	18 0.709	12 0.472	20 0.787	10 0.394	7 0.276	140 5.512	70 2.756	45 1.772	P.63
FD-H20-M1	36 1.417	18 0.709	12 0.472	20 0.787	10 0.394	7 0.276	140 5.512	70 2.756	45 1.772	P.63
FD-H25-L43 (Note 4)	—									P.63
FD-H25-L45 (Note 4)	—									P.63

Notes: 1) Note that the sensing range of the free-cut type fiber may be reduced by 20 % max. depending upon how the fiber is cut.
 2) The sensing range is specified for white non-glossy paper. (**FP-H18-L31** 50 × 50 mm **1.969 × 1.969 in.** glass substrate).
 3) Liquid inflow prevention joint, protective tube extension joint, fiber mounting joint are available. Please refer to p.38 for details.
 4) The sensing range is specified for transparent glass 100 × 100 × t0.7 mm **3.937 × 3.937 × t0.028 in**

FIBER SENSORS
 LASER SENSORS
 PHOTO-ELECTRIC SENSORS
 MICRO PHOTO-ELECTRIC SENSORS
 AREA SENSORS
 LIGHT CURTAINS / SAFETY COMPONENTS
 PRESSURE / FLOW SENSORS
 INDUCTIVE PROXIMITY SENSORS
 PARTICULAR USE SENSORS
 SENSOR OPTIONS
 SIMPLE WIRE-SAVING UNITS
 WIRE-SAVING SYSTEMS
 MEASUREMENT SENSORS
 STATIC ELECTRICITY PREVENTION DEVICES
 LASER MARKERS
 PLC
 HUMAN MACHINE INTERFACES
 ENERGY CONSUMPTION VISUALIZATION COMPONENTS
 FA COMPONENTS
 MACHINE VISION SYSTEMS
 UV CURING SYSTEMS

Selection Guide
 Fibers
 Fiber Amplifiers
FX-500
FX-100
FX-300
FX-410
FX-311
 FX-301-F7/
 FX-301-F

SENSING RANGE OF BLUE LED / GREEN LED / INFRARED LED

Reflective type



Fibers are listed in alphabetic order. Refer to p.5~ "Fiber Selection" for details of each fiber.



Model No.	Sensing range (mm in) (Note 1, 2) / Description									Dimensions
	FX-301B / 311B			FX-301G / 311G			FX-301H			
	LONG	STD	FAST	LONG	STD	FAST	LONG	STD	FAST	
FD-H30-KZ1V-S (Note 3,4)	30 to 40 1.181 to 1.575	—	—	—	—	—	—	—	—	P.64
FD-H30-L32	—	—	—	—	—	—	—	—	—	P.64
FD-H30-L32V-S (Note 3,4)	—	—	—	—	—	—	—	—	—	P.64
FD-H35-20S	22 0.866	11 0.433	7 0.276	12 0.472	6 0.236	4 0.157	80 3.150	40 1.575	28 1.102	P.64
FD-H35-M2	36 1.417	18 0.709	12 0.472	20 0.787	10 0.394	7 0.276	140 5.512	70 2.756	45 1.772	P.64
FD-H35-M2S6	36 1.417	18 0.709	12 0.472	20 0.787	10 0.394	7 0.276	140 5.512	70 2.756	45 1.772	P.64
FD-HF40Y (Note 5)	ø4 mm ø0.157 in form Protective tube: fluorine resin, length:500 mm 19.685 in (allowable cutting) Liquid surface not contacted: Beam received, Liquid surface contacted: Beam interrupted									P.64
FD-L10 (Note 6)	0 to 3.5 0 to 0.138	0 to 3 0 to 0.118	0.5 to 2.5 0.020 to 0.098	0 to 3 0 to 0.118	1 to 2 0.039 to 0.079	—	0 to 3 0 to 0.118	1 to 2 0.039 to 0.079	—	P.65
FD-L11 (Note 6)	7 0.276	6.5 0.256	0.5 to 5.5 0.020 to 0.217	6.5 0.256	1 to 4 0.039 to 0.157	—	6.5 0.256	1 to 4.5 0.039 to 0.177	—	P.65
FD-L12W (Note 6)	—	—	—	—	—	—	—	—	—	P.65
FD-L20H	4.5 to 10 0.177 to 0.394	5 to 9 0.197 to 0.354	5.5 to 8 0.217 to 0.315	5 to 9 0.197 to 0.354	5.5 to 8 0.217 to 0.315	—	4.9 to 8.5 0.193 to 0.335	—	—	P.65
FD-L21 (Note 6)	—	—	—	—	—	—	—	—	—	P.65
FD-L21W (Note 6)	—	—	—	—	—	—	—	—	—	P.65
FD-L22A (Note 6)	—	—	—	—	—	—	—	—	—	P.65
FD-L23 (Note 6)	—	—	—	—	—	—	—	—	—	P.65
FD-L30A (Note 6)	—	—	—	—	—	—	—	—	—	P.65
FD-L31A (Note 6)	—	—	—	—	—	—	—	—	—	P.65
FD-L32H (Note 6)	—	—	—	—	—	—	—	—	—	P.66
FD-R31G	17 0.669	8 0.315	5 0.197	8 0.315	4 0.157	2 0.079	9 0.354	4 0.157	2 0.079	P.66
FD-R32EG	6 0.236	3 0.118	1.5 0.059	2 0.079	1 0.039	—	8 0.315	4 0.157	2.5 0.098	P.66
FD-R33EG	2 0.079	0.8 0.031	0.5 0.020	1 0.039	—	—	3 0.118	1.5 0.059	—	P.66
FD-R34EG	5 0.197	2 0.079	1.5 0.059	2 0.079	1 0.039	—	6 0.236	3 0.118	2 0.079	P.66
FD-R41	24 0.945	1 to 13 0.039 to 0.512	1 to 9 0.039 to 0.354	1 to 15 0.039 to 0.591	1 to 8 0.039 to 0.315	3 to 6 0.118 to 0.236	14 0.551	1 to 6 0.039 to 0.236	1 to 3 0.039 to 0.118	P.66
FD-R60	42 1.654	20 0.787	0.5 to 13 0.020 to 0.512	21 0.827	0.5 to 10 0.020 to 0.394	0.5 to 7 0.020 to 0.276	27 1.063	12 0.472	8 0.315	P.66
FD-R61Y	36 1.417	17 0.669	0.5 to 11 0.020 to 0.433	19 0.748	0.5 to 9 0.020 to 0.354	1 to 6 0.039 to 0.236	19 0.748	0.5 to 10 0.020 to 0.394	0.5 to 6 0.020 to 0.236	P.66
FD-S21	8 0.315	3.5 0.138	2 0.079	5 0.197	2 0.079	1.3 0.051	9 0.354	4 0.157	3 0.118	P.66
FD-S30	19 0.749	9 0.354	6 0.236	9 0.354	4.5 0.177	2.5 0.098	8 0.315	4 0.157	2.5 0.098	P.67
FD-S31	18 0.709	8 0.315	5 0.197	8 0.315	4 0.157	2 0.079	7 0.276	3 0.118	2 0.079	P.67
FD-S32	48 1.890	24 0.945	16 0.630	26 1.024	13 0.512	8 0.315	27 1.063	12 0.472	8 0.315	P.67
FD-S32W	32 1.260	1 to 15 0.039 to 0.591	1 to 9 0.039 to 0.354	17 0.669	1 to 7.5 0.039 to 0.295	1.5 to 4.5 0.059 to 0.177	18 0.709	1 to 9 0.039 to 0.354	1.5 to 5 0.059 to 0.197	P.67
FD-S33GW	14 0.551	7 0.276	5 0.197	6 0.236	4 0.157	2 0.079	9 0.354	5 0.197	2 0.079	P.67
FD-S60Y	50 1.969	20 0.787	3 to 12 0.118 to 0.472	28 1.102	3 to 9 0.118 to 0.354	—	30 1.181	2 to 13 0.079 to 0.512	5 to 6.5 0.197 to 0.256	P.67
FD-V30	9 0.354	—	—	—	—	—	—	—	—	P.67
FD-V30W	—	—	—	—	—	—	—	—	—	P.67
FD-V50	12 0.472	—	—	6 0.236	—	—	6 0.236	—	—	P.68
FD-Z20HBW	4 to 10 0.157 to 0.394	—	—	—	—	—	3 to 11 0.118 to 0.433	4 to 6 0.157 to 0.236	—	P.68
FD-Z20W	—	—	—	—	—	—	5 to 8 0.197 to 0.315	—	—	P.68
FD-Z40HBW	1 to 36 0.039 to 1.417	3 to 17 1.181 to 0.689	3 to 11 1.181 to 0.433	2 to 19 0.079 to 0.748	3 to 8 0.118 to 0.315	4 to 5 0.157 to 0.197	2 to 20 0.0787 to 0.787	3 to 10 0.118 to 0.394	4 to 5.5 0.157 to 0.217	P.68
FD-Z40W	4 to 20 0.157 to 0.787	—	—	4 to 14 0.157 to 0.551	—	—	5 to 10 0.197 to 0.394	—	—	P.68
FD-Z50HW	—	—	—	—	—	—	—	—	—	P.68

- Notes: 1) The standard sensing objects of the sensing ranges vary depending on the fibers.
 2) Note that the sensing range of the free-cut type fiber may be reduced by 20 % max. depending upon how the fiber is cut.
 3) The sensing range of reflective type is the value for white non-glossy paper.
 4) Sold as a set comprising vacuum type fiber + photo-terminal (FV-BR1) + fiber at atmospheric side (FT-J8).
 5) Liquid inflow prevention joint, protective tube extension joint, fiber mounting joint are available. Please refer to p.38 for details.
 6) The sensing range is specified for transparent glass 100 × 100 × t.0.07 mm 3.937 × 3.937 × t.0.028 in, (FD-L32H: R-edge, FD-L21 and FD-L21W: t2 mm t0.079 in) [FD-L10: silicon wafers 100 × 100 mm 3.937 × 3.937 in]

FIBER OPTIONS

Refer to p. 69~ for details of lens dimensions.

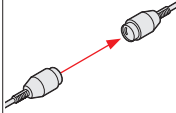
Lens (for thru-beam type fiber)

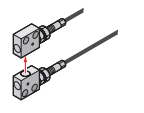
Designation	Model No.	Description																																																																								
For thru-beam type fiber	Expansion lens (Note 1)	FX-LE1	 <p>Increases the sensing range by 5 times or more.</p> <ul style="list-style-type: none"> Ambient temperature: -60 to +350 °C -76 to +662 °F (Note 5) Beam dia: ø3.6 mm ø0.142 in 																																																																							
			<p>Sensing range for red LED type (mm) [Lens on both sides] (Note 2)</p> <table border="1"> <thead> <tr> <th>Mode Fiber</th> <th>U-LG</th> <th>LONG</th> <th>STDF</th> <th>STD</th> <th>FAST</th> <th>S-D</th> <th>H-SP</th> </tr> </thead> <tbody> <tr> <td>FT-43</td> <td>3,600 (Note 3)</td> <td>3,600 (Note 3)</td> <td>3,600 (Note 3)</td> <td>2,900</td> <td>2,100</td> <td>1,300</td> <td>1,200</td> </tr> <tr> <td>FT-42</td> <td>3,600 (Note 3)</td> <td>3,600 (Note 3)</td> <td>3,600 (Note 3)</td> <td>3,600 (Note 3)</td> <td>2,800</td> <td>1,600</td> <td>1,600</td> </tr> <tr> <td>FT-45X</td> <td>1,600 (Note 3)</td> <td>1,600 (Note 3)</td> <td>1,600 (Note 3)</td> <td>1,600 (Note 3)</td> <td>1,600 (Note 3)</td> <td>1,600 (Note 3)</td> <td>1,500</td> </tr> <tr> <td>FT-R40</td> <td>3,600 (Note 3)</td> <td>3,600 (Note 3)</td> <td>3,500</td> <td>3,400</td> <td>2,700</td> <td>1,500</td> <td>1,500</td> </tr> <tr> <td>FT-H35-M2</td> <td>3,500 (Note 3)</td> <td>3,500 (Note 3)</td> <td>2,500</td> <td>2,000</td> <td>1,500</td> <td>750</td> <td>700</td> </tr> <tr> <td>FT-H20W-M1</td> <td>1,600 (Note 3)</td> <td>1,600 (Note 3)</td> <td>1,600 (Note 3)</td> <td>1,300</td> <td>900</td> <td>500</td> <td>400</td> </tr> <tr> <td>FT-H20-M1</td> <td>1,600 (Note 3)</td> <td>1,600 (Note 3)</td> <td>1,600 (Note 3)</td> <td>1,600 (Note 3)</td> <td>1,100</td> <td>900</td> <td>600</td> </tr> </tbody> </table>	Mode Fiber	U-LG	LONG	STDF	STD	FAST	S-D	H-SP	FT-43	3,600 (Note 3)	3,600 (Note 3)	3,600 (Note 3)	2,900	2,100	1,300	1,200	FT-42	3,600 (Note 3)	3,600 (Note 3)	3,600 (Note 3)	3,600 (Note 3)	2,800	1,600	1,600	FT-45X	1,600 (Note 3)	1,600 (Note 3)	1,600 (Note 3)	1,600 (Note 3)	1,600 (Note 3)	1,600 (Note 3)	1,500	FT-R40	3,600 (Note 3)	3,600 (Note 3)	3,500	3,400	2,700	1,500	1,500	FT-H35-M2	3,500 (Note 3)	3,500 (Note 3)	2,500	2,000	1,500	750	700	FT-H20W-M1	1,600 (Note 3)	1,600 (Note 3)	1,600 (Note 3)	1,300	900	500	400	FT-H20-M1	1,600 (Note 3)	1,600 (Note 3)	1,600 (Note 3)	1,600 (Note 3)	1,100	900	600							
	Mode Fiber	U-LG	LONG	STDF	STD	FAST	S-D	H-SP																																																																		
	FT-43	3,600 (Note 3)	3,600 (Note 3)	3,600 (Note 3)	2,900	2,100	1,300	1,200																																																																		
	FT-42	3,600 (Note 3)	3,600 (Note 3)	3,600 (Note 3)	3,600 (Note 3)	2,800	1,600	1,600																																																																		
FT-45X	1,600 (Note 3)	1,600 (Note 3)	1,600 (Note 3)	1,600 (Note 3)	1,600 (Note 3)	1,600 (Note 3)	1,500																																																																			
FT-R40	3,600 (Note 3)	3,600 (Note 3)	3,500	3,400	2,700	1,500	1,500																																																																			
FT-H35-M2	3,500 (Note 3)	3,500 (Note 3)	2,500	2,000	1,500	750	700																																																																			
FT-H20W-M1	1,600 (Note 3)	1,600 (Note 3)	1,600 (Note 3)	1,300	900	500	400																																																																			
FT-H20-M1	1,600 (Note 3)	1,600 (Note 3)	1,600 (Note 3)	1,600 (Note 3)	1,100	900	600																																																																			
Super-expansion lens (Note 1)	FX-LE2	 <p>Tremendously increases the sensing range with large diameter lenses.</p> <ul style="list-style-type: none"> Ambient temperature: -60 to +350 °C -76 to +662 °F (Note 5) Beam dia: ø9.8 mm ø0.386 in 																																																																								
		<p>Sensing range for red LED type (mm) [Lens on both sides] (Note 2)</p> <table border="1"> <thead> <tr> <th>Mode Fiber</th> <th>U-LG</th> <th>LONG</th> <th>STDF</th> <th>STD</th> <th>FAST</th> <th>S-D</th> <th>H-SP</th> </tr> </thead> <tbody> <tr> <td>FT-43</td> <td>3,600 (Note 3)</td> <td>3,600 (Note 3)</td> <td>3,600 (Note 3)</td> <td>3,600 (Note 3)</td> <td>3,600 (Note 3)</td> <td>3,600 (Note 3)</td> <td>3,600 (Note 3)</td> </tr> <tr> <td>FT-42</td> <td>3,600 (Note 3)</td> <td>3,600 (Note 3)</td> <td>3,600 (Note 3)</td> <td>3,600 (Note 3)</td> <td>3,600 (Note 3)</td> <td>3,600 (Note 3)</td> <td>3,600 (Note 3)</td> </tr> <tr> <td>FT-45X</td> <td>1,600 (Note 3)</td> <td>1,600 (Note 3)</td> <td>1,600 (Note 3)</td> <td>1,600 (Note 3)</td> <td>1,600 (Note 3)</td> <td>1,600 (Note 3)</td> <td>1,600 (Note 3)</td> </tr> <tr> <td>FT-R40</td> <td>3,600 (Note 3)</td> <td>3,600 (Note 3)</td> <td>3,600 (Note 3)</td> <td>3,600 (Note 3)</td> <td>3,600 (Note 3)</td> <td>3,600 (Note 3)</td> <td>3,600 (Note 3)</td> </tr> <tr> <td>FT-H35-M2</td> <td>3,500 (Note 3)</td> <td>3,500 (Note 3)</td> <td>3,500 (Note 3)</td> <td>3,500 (Note 3)</td> <td>3,500 (Note 3)</td> <td>3,500 (Note 3)</td> <td>3,500 (Note 3)</td> </tr> <tr> <td>FT-H20W-M1</td> <td>1,600 (Note 3)</td> <td>1,600 (Note 3)</td> <td>1,600 (Note 3)</td> <td>1,600 (Note 3)</td> <td>1,600 (Note 3)</td> <td>1,500</td> <td>1,600 (Note 3)</td> </tr> <tr> <td>FT-H20-M1</td> <td>1,600 (Note 3)</td> <td>1,600 (Note 3)</td> <td>1,600 (Note 3)</td> <td>1,600 (Note 3)</td> <td>1,600 (Note 3)</td> <td>1,600 (Note 3)</td> <td>1,600 (Note 3)</td> </tr> <tr> <td>FT-H13-FM2</td> <td>3,500 (Note 3)</td> <td>3,500 (Note 3)</td> <td>3,500 (Note 3)</td> <td>3,500 (Note 3)</td> <td>3,500 (Note 3)</td> <td>3,500 (Note 3)</td> <td>3,500 (Note 3)</td> </tr> </tbody> </table>	Mode Fiber	U-LG	LONG	STDF	STD	FAST	S-D	H-SP	FT-43	3,600 (Note 3)	3,600 (Note 3)	3,600 (Note 3)	3,600 (Note 3)	3,600 (Note 3)	3,600 (Note 3)	3,600 (Note 3)	FT-42	3,600 (Note 3)	3,600 (Note 3)	3,600 (Note 3)	3,600 (Note 3)	3,600 (Note 3)	3,600 (Note 3)	3,600 (Note 3)	FT-45X	1,600 (Note 3)	1,600 (Note 3)	1,600 (Note 3)	1,600 (Note 3)	1,600 (Note 3)	1,600 (Note 3)	1,600 (Note 3)	FT-R40	3,600 (Note 3)	3,600 (Note 3)	3,600 (Note 3)	3,600 (Note 3)	3,600 (Note 3)	3,600 (Note 3)	3,600 (Note 3)	FT-H35-M2	3,500 (Note 3)	3,500 (Note 3)	3,500 (Note 3)	3,500 (Note 3)	3,500 (Note 3)	3,500 (Note 3)	3,500 (Note 3)	FT-H20W-M1	1,600 (Note 3)	1,600 (Note 3)	1,600 (Note 3)	1,600 (Note 3)	1,600 (Note 3)	1,500	1,600 (Note 3)	FT-H20-M1	1,600 (Note 3)	1,600 (Note 3)	1,600 (Note 3)	1,600 (Note 3)	1,600 (Note 3)	1,600 (Note 3)	1,600 (Note 3)	FT-H13-FM2	3,500 (Note 3)	3,500 (Note 3)	3,500 (Note 3)	3,500 (Note 3)	3,500 (Note 3)	3,500 (Note 3)	3,500 (Note 3)
Mode Fiber	U-LG	LONG	STDF	STD	FAST	S-D	H-SP																																																																			
FT-43	3,600 (Note 3)	3,600 (Note 3)	3,600 (Note 3)	3,600 (Note 3)	3,600 (Note 3)	3,600 (Note 3)	3,600 (Note 3)																																																																			
FT-42	3,600 (Note 3)	3,600 (Note 3)	3,600 (Note 3)	3,600 (Note 3)	3,600 (Note 3)	3,600 (Note 3)	3,600 (Note 3)																																																																			
FT-45X	1,600 (Note 3)	1,600 (Note 3)	1,600 (Note 3)	1,600 (Note 3)	1,600 (Note 3)	1,600 (Note 3)	1,600 (Note 3)																																																																			
FT-R40	3,600 (Note 3)	3,600 (Note 3)	3,600 (Note 3)	3,600 (Note 3)	3,600 (Note 3)	3,600 (Note 3)	3,600 (Note 3)																																																																			
FT-H35-M2	3,500 (Note 3)	3,500 (Note 3)	3,500 (Note 3)	3,500 (Note 3)	3,500 (Note 3)	3,500 (Note 3)	3,500 (Note 3)																																																																			
FT-H20W-M1	1,600 (Note 3)	1,600 (Note 3)	1,600 (Note 3)	1,600 (Note 3)	1,600 (Note 3)	1,500	1,600 (Note 3)																																																																			
FT-H20-M1	1,600 (Note 3)	1,600 (Note 3)	1,600 (Note 3)	1,600 (Note 3)	1,600 (Note 3)	1,600 (Note 3)	1,600 (Note 3)																																																																			
FT-H13-FM2	3,500 (Note 3)	3,500 (Note 3)	3,500 (Note 3)	3,500 (Note 3)	3,500 (Note 3)	3,500 (Note 3)	3,500 (Note 3)																																																																			
Side-view lens	FX-SV1	 <p>Beam axis is bent by 90°.</p> <ul style="list-style-type: none"> Ambient temperature: -60 to +300 °C -76 to +572 °F (Note 5) Beam dia: ø2.8 mm ø0.110 in 																																																																								
		<p>Sensing range for red LED type (mm) [Lens on both sides] (Note 2)</p> <table border="1"> <thead> <tr> <th>Mode Fiber</th> <th>U-LG</th> <th>LONG</th> <th>STDF</th> <th>STD</th> <th>FAST</th> <th>S-D</th> <th>H-SP</th> </tr> </thead> <tbody> <tr> <td>FT-43</td> <td>1,900</td> <td>1,200</td> <td>840</td> <td>580</td> <td>420</td> <td>250</td> <td>240</td> </tr> <tr> <td>FT-42</td> <td>2,100</td> <td>1,400</td> <td>870</td> <td>640</td> <td>440</td> <td>210</td> <td>210</td> </tr> <tr> <td>FT-45X</td> <td>1,600 (Note 3)</td> <td>1,600 (Note 3)</td> <td>840</td> <td>650</td> <td>450</td> <td>220</td> <td>220</td> </tr> <tr> <td>FT-H35-M2</td> <td>840</td> <td>550</td> <td>370</td> <td>280</td> <td>200</td> <td>90</td> <td>90</td> </tr> <tr> <td>FT-H20W-M1</td> <td>400</td> <td>310</td> <td>180</td> <td>140</td> <td>100</td> <td>50</td> <td>50</td> </tr> <tr> <td>FT-H20-M1</td> <td>840</td> <td>550</td> <td>370</td> <td>280</td> <td>200</td> <td>90</td> <td>90</td> </tr> </tbody> </table>	Mode Fiber	U-LG	LONG	STDF	STD	FAST	S-D	H-SP	FT-43	1,900	1,200	840	580	420	250	240	FT-42	2,100	1,400	870	640	440	210	210	FT-45X	1,600 (Note 3)	1,600 (Note 3)	840	650	450	220	220	FT-H35-M2	840	550	370	280	200	90	90	FT-H20W-M1	400	310	180	140	100	50	50	FT-H20-M1	840	550	370	280	200	90	90																
Mode Fiber	U-LG	LONG	STDF	STD	FAST	S-D	H-SP																																																																			
FT-43	1,900	1,200	840	580	420	250	240																																																																			
FT-42	2,100	1,400	870	640	440	210	210																																																																			
FT-45X	1,600 (Note 3)	1,600 (Note 3)	840	650	450	220	220																																																																			
FT-H35-M2	840	550	370	280	200	90	90																																																																			
FT-H20W-M1	400	310	180	140	100	50	50																																																																			
FT-H20-M1	840	550	370	280	200	90	90																																																																			
Expansion lens for vacuum fiber (Note 1)	FV-LE1	 <p>Sensing range increases by 4 times or more.</p> <ul style="list-style-type: none"> Ambient temperature: -60 to +350 °C -76 to +662 °F (Note 5) Beam dia: ø3.6 mm ø0.142 in 																																																																								
		<p>Sensing range for red LED type (mm) [Lens on both sides] (Note 2, 4)</p> <table border="1"> <thead> <tr> <th>Mode Fiber</th> <th>U-LG</th> <th>LONG</th> <th>STDF</th> <th>STD</th> <th>FAST</th> <th>S-D</th> <th>H-SP</th> </tr> </thead> <tbody> <tr> <td>FT-H30-M1V-S</td> <td>1,600</td> <td>1,200</td> <td>650</td> <td>450</td> <td>300</td> <td>150</td> <td>200</td> </tr> </tbody> </table>	Mode Fiber	U-LG	LONG	STDF	STD	FAST	S-D	H-SP	FT-H30-M1V-S	1,600	1,200	650	450	300	150	200																																																								
Mode Fiber	U-LG	LONG	STDF	STD	FAST	S-D	H-SP																																																																			
FT-H30-M1V-S	1,600	1,200	650	450	300	150	200																																																																			
Vacuum resistant side-view lens (Note 1)	FV-SV2	 <p>Beam axis is bent by 90°.</p> <ul style="list-style-type: none"> Ambient temperature: -60 to +300 °C -76 to +572 °F (Note 5) Beam dia: ø3.7 mm ø0.146 in 																																																																								
		<p>Sensing range for red LED type (mm) [Lens on both sides] (Note 2, 4)</p> <table border="1"> <thead> <tr> <th>Mode Fiber</th> <th>U-LG</th> <th>LONG</th> <th>STDF</th> <th>STD</th> <th>FAST</th> <th>S-D</th> <th>H-SP</th> </tr> </thead> <tbody> <tr> <td>FT-H30-M1V-S</td> <td>1,600</td> <td>1,200</td> <td>650</td> <td>450</td> <td>300</td> <td>150</td> <td>200</td> </tr> </tbody> </table>	Mode Fiber	U-LG	LONG	STDF	STD	FAST	S-D	H-SP	FT-H30-M1V-S	1,600	1,200	650	450	300	150	200																																																								
Mode Fiber	U-LG	LONG	STDF	STD	FAST	S-D	H-SP																																																																			
FT-H30-M1V-S	1,600	1,200	650	450	300	150	200																																																																			

- Notes: 1) Be careful sure to use it only after you have adjusted it sufficiently when installing the thru-beam type fiber equipped with the expansion lens, as the beam envelope becomes narrow and alignment is difficult.
 2) The sensing ranges are the values for red LED type amplifier. Please contact our office for details on sensing ranges for other types of amplifiers.
 3) The fiber cable length practically limits the sensing range.
 4) The fiber cable length for the **FT-H30-M1V-S** is 1 m **3.281 ft**. The sensing ranges in U-LG and LONG modes take into account the length of the **FT-J8** atmospheric side fiber.
 5) Refer to p.15, p.18, p.33 and p.35 for the ambient temperatures of fibers to be used in combination.

FIBER SENSORS

LASER SENSORS

PHOTO-ELECTRIC SENSORS

MICRO PHOTO-ELECTRIC SENSORS

AREA SENSORS

LIGHT CURTAINS / SAFETY COMPONENTS

PRESSURE / FLOW SENSORS

INDUCTIVE PROXIMITY SENSORS

PARTICULAR USE SENSORS

SENSOR OPTIONS

SIMPLE WIRE-SAVING UNITS

WIRE-SAVING SYSTEMS

MEASUREMENT SENSORS

STATIC ELECTRICITY PREVENTION DEVICES

LASER MARKERS

PLC

HUMAN MACHINE INTERFACES

ENERGY CONSUMPTION VISUALIZATION COMPONENTS

FA COMPONENTS

MACHINE VISION SYSTEMS

UV CURING SYSTEMS

Selection Guide

Fibers

Fiber Amplifiers

FX-500

FX-100

FX-300

FX-410

FX-311

FX-301-F7/

FX-301-F

FIBER OPTIONS





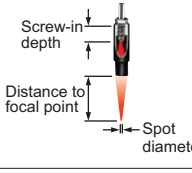
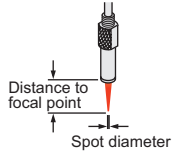
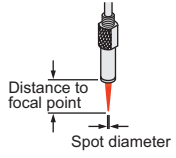
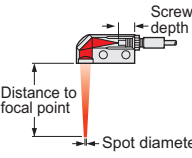





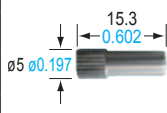
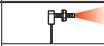

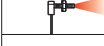
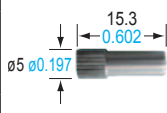

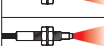

Refer to p. 69~ for details of lens dimensions.

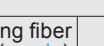
Lens (for reflective type fiber)

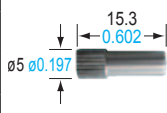
Designation	Model No.	Description												
For reflective type fiber	Pinpoint spot lens FX-MR1	 <p>Pinpoint spot of $\phi 0.5$ mm $\phi 0.020$ in. Enables detection of minute objects or small marks. • Distance to focal point: 6 ± 1 mm 0.236 ± 0.039 in • Applicable fibers: FD-42G, FD-42GW • Ambient temperature: -40 to $+70$ °C -40 to $+158$ °F (Note)</p>												
	Zoom lens FX-MR2	 <p>The spot diameter is adjustable from $\phi 0.7$ to $\phi 2$ mm $\phi 0.028$ to $\phi 0.079$ in according to how much the fiber is screwed in. • Applicable fibers: FD-42G, FD-42GW • Ambient temperature: -40 to $+70$ °C -40 to $+158$ °F (Note 2) • Accessory: MS-EX3 (mounting bracket)</p> <p>Sensing range for red LED type (Note 1)</p> <table border="1"> <thead> <tr> <th>Screw-in depth</th> <th>Distance to focal point</th> <th>Spot diameter</th> </tr> </thead> <tbody> <tr> <td>7 mm</td> <td>18.5 mm approx.</td> <td>$\phi 0.7$ mm</td> </tr> <tr> <td>12 mm</td> <td>27 mm approx.</td> <td>$\phi 1.2$ mm</td> </tr> <tr> <td>14 mm</td> <td>43 mm approx.</td> <td>$\phi 2.0$ mm</td> </tr> </tbody> </table>	Screw-in depth	Distance to focal point	Spot diameter	7 mm	18.5 mm approx.	$\phi 0.7$ mm	12 mm	27 mm approx.	$\phi 1.2$ mm	14 mm	43 mm approx.	$\phi 2.0$ mm
	Screw-in depth	Distance to focal point	Spot diameter											
	7 mm	18.5 mm approx.	$\phi 0.7$ mm											
	12 mm	27 mm approx.	$\phi 1.2$ mm											
14 mm	43 mm approx.	$\phi 2.0$ mm												
Finest spot lens FX-MR3	 <p>Extremely fine spot of $\phi 0.15$ mm $\phi 0.006$ in approx. achieved. • Applicable fibers: FD-EG31, FD-EG30, FD-42G, FD-42GW, FD-32G, FD-32GX • Ambient temperature: -40 to $+70$ °C -40 to $+158$ °F (Note 2)</p> <p>Sensing range for red LED type (Note 1)</p> <table border="1"> <thead> <tr> <th>Fiber model No.</th> <th>Distance to focal point</th> <th>Spot diameter</th> </tr> </thead> <tbody> <tr> <td>FD-EG31</td> <td>7.5 ± 0.5 mm</td> <td>$\phi 0.15$ mm approx.</td> </tr> <tr> <td>FD-EG30</td> <td>7.5 ± 0.5 mm</td> <td>$\phi 0.3$ mm approx.</td> </tr> <tr> <td>FD-42G/42GW FD-32G/32GX</td> <td>7.5 ± 0.5 mm</td> <td>$\phi 0.5$ mm approx.</td> </tr> </tbody> </table>	Fiber model No.	Distance to focal point	Spot diameter	FD-EG31	7.5 ± 0.5 mm	$\phi 0.15$ mm approx.	FD-EG30	7.5 ± 0.5 mm	$\phi 0.3$ mm approx.	FD-42G/42GW FD-32G/32GX	7.5 ± 0.5 mm	$\phi 0.5$ mm approx.	
Fiber model No.	Distance to focal point	Spot diameter												
FD-EG31	7.5 ± 0.5 mm	$\phi 0.15$ mm approx.												
FD-EG30	7.5 ± 0.5 mm	$\phi 0.3$ mm approx.												
FD-42G/42GW FD-32G/32GX	7.5 ± 0.5 mm	$\phi 0.5$ mm approx.												
Finest spot lens FX-MR6	 <p>Extremely fine spot of $\phi 0.1$ mm $\phi 0.004$ in approx. achieved. • Applicable fibers: FD-EG31, FD-EG30, FD-42G, FD-42GW, FD-32G, FD-32GX • Ambient temperature: -20 to $+60$ °C -4 to $+140$ °F (Note 2)</p> <p>Sensing range for red LED type (Note 1)</p> <table border="1"> <thead> <tr> <th>Fiber model No.</th> <th>Distance to focal point</th> <th>Spot diameter</th> </tr> </thead> <tbody> <tr> <td>FD-EG31</td> <td>7 ± 0.5 mm</td> <td>$\phi 0.1$ mm approx.</td> </tr> <tr> <td>FD-EG30</td> <td>7 ± 0.5 mm</td> <td>$\phi 0.2$ mm approx.</td> </tr> <tr> <td>FD-42G/42GW FD-32G/32GX</td> <td>7 ± 0.5 mm</td> <td>$\phi 0.4$ mm approx.</td> </tr> </tbody> </table>	Fiber model No.	Distance to focal point	Spot diameter	FD-EG31	7 ± 0.5 mm	$\phi 0.1$ mm approx.	FD-EG30	7 ± 0.5 mm	$\phi 0.2$ mm approx.	FD-42G/42GW FD-32G/32GX	7 ± 0.5 mm	$\phi 0.4$ mm approx.	
Fiber model No.	Distance to focal point	Spot diameter												
FD-EG31	7 ± 0.5 mm	$\phi 0.1$ mm approx.												
FD-EG30	7 ± 0.5 mm	$\phi 0.2$ mm approx.												
FD-42G/42GW FD-32G/32GX	7 ± 0.5 mm	$\phi 0.4$ mm approx.												
Zoom lens (side-view type) FX-MR5	 <p>FX-MR2 is converted into a side-view type and can be mounted in a very small space. • Applicable fibers: FD-42G, FD-42GW • Ambient temperature: -40 to $+70$ °C -40 to $+158$ °F (Note 2)</p> <p>Sensing range for red LED type (Note 1)</p> <table border="1"> <thead> <tr> <th>Screw-in depth</th> <th>Distance to focal point</th> <th>Spot diameter</th> </tr> </thead> <tbody> <tr> <td>8 mm</td> <td>13 mm approx.</td> <td>$\phi 0.5$ mm</td> </tr> <tr> <td>10 mm</td> <td>15 mm approx.</td> <td>$\phi 0.8$ mm</td> </tr> <tr> <td>14 mm</td> <td>30 mm approx.</td> <td>$\phi 3.0$ mm</td> </tr> </tbody> </table>	Screw-in depth	Distance to focal point	Spot diameter	8 mm	13 mm approx.	$\phi 0.5$ mm	10 mm	15 mm approx.	$\phi 0.8$ mm	14 mm	30 mm approx.	$\phi 3.0$ mm	
Screw-in depth	Distance to focal point	Spot diameter												
8 mm	13 mm approx.	$\phi 0.5$ mm												
10 mm	15 mm approx.	$\phi 0.8$ mm												
14 mm	30 mm approx.	$\phi 3.0$ mm												

Notes: 1) The sensing ranges are the values when used in combination with a red LED type amplifier. Please contact our office for details on sensing ranges for other types of amplifier.
 2) Refer to p.16 or p.26 for the ambient temperatures of fibers to be used in combination.

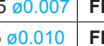
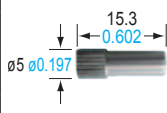
Lens (For square head M3 reflective fiber)

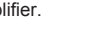
Type	Spot diameter (mm in) (Note)	Distance to focal point (mm in) (Note)	Lens		Fiber			
			Shape (mm in)	Model No.	Shape	Emitting fiber core (mm in)	Model No.	
For Square head M3 reflective fiber	$\phi 0.1$ $\phi 0.004$ approx.	7 ± 0.5 0.276 ± 0.020	$\phi 5$ $\phi 0.197$		FX-MR7		$\phi 0.125$ $\phi 0.005$	FD-R33EG
							$\phi 0.125$ $\phi 0.005$	FD-EG31
							$\phi 0.175$ $\phi 0.007$	FD-R34EG
							$\phi 0.25$ $\phi 0.010$	FD-R32EG
For Square head M3 reflective fiber	$\phi 0.15$ $\phi 0.006$ approx.	7 ± 0.5 0.276 ± 0.020	$\phi 5$ $\phi 0.197$		FX-MR7		$\phi 0.25$ $\phi 0.010$	FD-EG30
							$\phi 0.5$ $\phi 0.020$	FD-R31G
							$\phi 0.5$ $\phi 0.020$	FD-32G
							$\phi 0.5$ $\phi 0.020$	FD-32GX
							$\phi 0.5$ $\phi 0.020$	FD-42G
							$\phi 0.5$ $\phi 0.020$	FD-42GW
							$\phi 0.5$ $\phi 0.020$	
							$\phi 0.5$ $\phi 0.020$	
For Square head M3 reflective fiber	$\phi 0.2$ $\phi 0.008$ approx.	7 ± 0.5 0.276 ± 0.020	$\phi 5$ $\phi 0.197$		FX-MR7		$\phi 0.25$ $\phi 0.010$	FD-R32EG, FD-EG30
							$\phi 0.5$ $\phi 0.020$	FD-R31G, FD-32G, FD-32GX, FD-42G, FD-42GW
							$\phi 0.125$ $\phi 0.005$	FD-R33EG, FD-EG31
							$\phi 0.175$ $\phi 0.007$	FD-R34EG
For Square head M3 reflective fiber	$\phi 0.4$ $\phi 0.016$ approx.	7 ± 0.5 0.276 ± 0.020	$\phi 5$ $\phi 0.197$		FX-MR7		$\phi 0.25$ $\phi 0.010$	FD-R32EG, FD-EG30
							$\phi 0.5$ $\phi 0.020$	FD-R31G, FD-32G, FD-32GX, FD-42G, FD-42GW

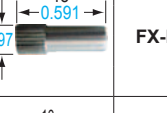
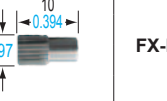
Type	Spot diameter (mm in) (Note)	Sensing range (mm in) (Note)	Lens		Applicable fibers		
			Shape (mm in)	Model No.	Emitting fiber core (mm in)	Model No.	
For Square head M3 reflective fiber	Zoom lens	10 to 30 0.394 to 1.181	$\phi 5$ $\phi 0.197$		FX-MR8	$\phi 0.125$ $\phi 0.005$	FD-R33EG, FD-EG31
						$\phi 0.175$ $\phi 0.007$	FD-R34EG
						$\phi 0.25$ $\phi 0.010$	FD-R32EG, FD-EG30
						$\phi 0.5$ $\phi 0.020$	FD-R31G, FD-32G, FD-32GX, FD-42G, FD-42GW
For Square head M3 reflective fiber	Parallel light lens	0 to 30 0 to 1.181	$\phi 5$ $\phi 0.197$		FX-MR9	$\phi 0.125$ $\phi 0.005$	FD-R33EG, FD-EG31
						$\phi 0.175$ $\phi 0.007$	FD-R34EG
						$\phi 0.25$ $\phi 0.010$	FD-R32EG, FD-EG30
						$\phi 0.5$ $\phi 0.020$	FD-R31G, FD-32G, FD-32GX, FD-42G, FD-42GW

Note: Spot diameter, distance to focal point and sensing range are specified for a red LED type amplifier.

FIBER SENSORS
 LASER SENSORS
 PHOTO-ELECTRIC SENSORS
 MICRO PHOTO-ELECTRIC SENSORS
 AREA SENSORS
 LIGHT CURTAINS / SAFETY COMPONENTS
 PRESSURE / FLOW SENSORS
 INDUCTIVE PROXIMITY SENSORS
 PARTICULAR USE SENSORS
 SENSOR OPTIONS
 SIMPLE WIRE-SAVING UNITS
 WIRE-SAVING SYSTEMS
 MEASUREMENT SENSORS
 STATIC ELECTRICITY PREVENTION DEVICES
 LASER MARKERS
 PLC
 HUMAN MACHINE INTERFACES
 ENERGY CONSUMPTION VISUALIZATION COMPONENTS
 FA COMPONENTS
 MACHINE VISION SYSTEMS
 UV CURING SYSTEMS
 Selection Guide
 Fibers
 Fiber Amplifiers
FX-500
FX-100
FX-300
FX-410
FX-311
 FX-301-F7/
 FX-301-F

FIBER OPTIONS

Refer to p. 69~ for details of lens dimensions.

Others

Designation	Model No.	Description					
Protective tube for thru-beam type fiber	FTP-500 (0.5 m 1.640 ft)	For M4 thread	Applicable fibers	FT-42 FT-42S FT-42W	FT-43 FT-H13-FM2		
	FTP-1000 (1 m 3.281 ft)						
	FTP-1500 (1.5 m 4.921 ft)	For M3 thread		FT-31 FT-31S FT-31W	FD-31 FD-31W		
	FTP-N500 (0.5 m 1.640 ft)						
	FTP-N1000 (1 m 3.281 ft)						
FTP-N1500 (1.5 m 4.921 ft)	For M6 thread	FD-61 FD-61G FD-61S FD-61W	FD-62 FD-H13-FM2				
FDP-500 (0.5 m 1.640 ft)							
FDP-1000 (1 m 3.281 ft)							
FDP-1500 (1.5 m 4.921 ft)							
FDP-N500 (0.5 m 1.640 ft)							
Protective tube for reflective type fiber	FDP-N1000 (1 m 3.281 ft)	For M4 thread	Applicable fibers	FD-41 FD-41W	FD-41S FD-41SW		
	FDP-N1500 (1.5 m 4.921 ft)						
	FDP-500 (0.5 m 1.640 ft)	For M6 thread		FD-61 FD-61G FD-61S FD-61W	FD-62 FD-H13-FM2		
	FDP-1000 (1 m 3.281 ft)						
	FDP-1500 (1.5 m 4.921 ft)						
Fiber bender	FB-1	The fiber bender bends the sleeve part of the fiber head at the proper radius. (Note 1)					
Universal sensor mounting stand (Note 2)	MS-AJ1-F	Horizontal mounting type		Mounting stand assembly for fiber (For M3, M4 or M6 threaded head fiber)			
	MS-AJ2-F	Vertical mounting type					
Liquid inflow prevention joint (Note 2)	MS-FX-01Y	Applicable fibers	FD-HF40Y FD-F41Y	This joint suppresses false operations due to liquid slip-in from the top of the protective tube.			
Protective tube extension joint (Note 2)	MS-FX-02Y			The protective tube can be extended.			
Fiber mounting joint (Note 2)	MS-FX-03Y			The joint is used for mounting fibers on a tank.			
Single core holder	FX-AT15A			The incident light intensity may vary when using a multi-core fiber or a thin type sharp bending fiber. This holder suppresses the variation in the incident light intensity. (Brown)			
Reflector	RF-210			Used with FR-Z50HW. Refer to p.30 or p.41 for the sensing range of FR-Z50HW to be used in combination.			
	RF-220						
	RF-230						

Notes: 1) Do not bend the sleeve part of any side-view type fiber or ultra-small diameter head type fiber.
2) The joint internal ferrule (MS-FX-YF) is available as a spare part. A distorted ferrule may result in leakage.

Liquid inflow prevention joint

- MS-FX-01Y

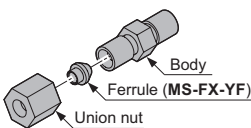

Protective tube extension joint

- MS-FX-02Y

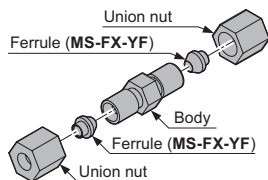

Fiber mounting joint

- MS-FX-03Y

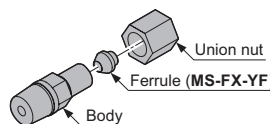

Reflector

- RF-210

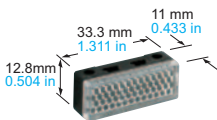

- RF-220

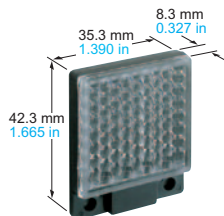

- RF-230

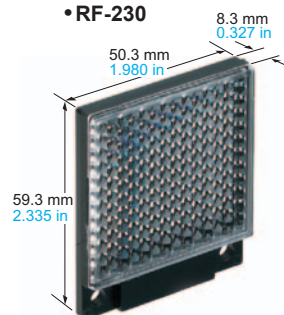

Protective tube

- FTP-□
- FDP-□



Fiber bender

- FB-1

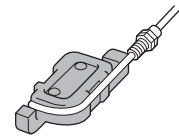

Universal sensor mounting stand

Using the arm which enables adjustment in the horizontal direction, sensing can also be done from above an assembly line.

- MS-AJ1-F

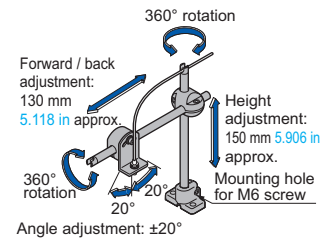

- MS-AJ2-F

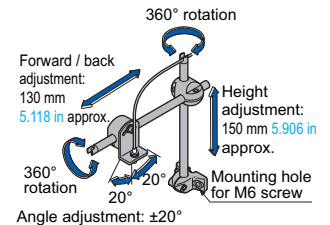

Single core holder

- FX-AT15A



FIBER SENSORS

LASER SENSORS

PHOTO-ELECTRIC SENSORS

MICRO PHOTO-ELECTRIC SENSORS

AREA SENSORS

LIGHT CURTAINS / SAFETY COMPONENTS

PRESSURE / FLOW SENSORS

INDUCTIVE PROXIMITY SENSORS

PARTICULAR USE SENSORS

SENSOR OPTIONS

SMALL WIRE-SAVING UNITS

WIRE-SAVING SYSTEMS

MEASUREMENT SENSORS

STATIC ELECTRICITY PREVENTION DEVICES

LASER MARKERS

PLC

HUMAN MACHINE INTERFACES

ENERGY CONSUMPTION VISUALIZATION COMPONENTS

FA COMPONENTS

MACHINE VISION SYSTEMS

UV CURING SYSTEMS

Selection Guide

Fibers

Fiber Amplifiers

FX-500

FX-100

FX-300

FX-410

FX-311

FX-301-F7/

FX-301-F

SPECIFICATIONS

FIBER SENSORS
LASER SENSORS
PHOTO-ELECTRIC SENSORS
MICRO PHOTO-ELECTRIC SENSORS
AREA SENSORS
LIGHT CURTAINS / SAFETY COMPONENTS
PRESSURE / FLOW SENSORS
INDUCTIVE PROXIMITY SENSORS
PARTICULAR USE SENSORS
SENSOR OPTIONS
SIMPLE WIRE-SAVING UNITS
WIRE-SAVING SYSTEMS
MEASUREMENT SENSORS
STATIC ELECTRICITY PREVENTION DEVICES
LASER MARKERS
PLC
HUMAN MACHINE INTERFACES
ENERGY CONSUMPTION VISUALIZATION COMPONENTS
FA COMPONENTS
MACHINE VISION SYSTEMS
UV CURING SYSTEMS

Item	Model No.	Type	Standard type				High-speed type	High-function type
			Red LED	Blue LED	Green LED	Infrared LED		
		NPN output	FX-301	FX-301B	FX-301G	FX-301H	FX-301-HS	FX-305
		PNP output	FX-301P	FX-301BP	FX-301GP	FX-301HP	FX-301P-HS	FX-305P
Supply voltage	12 to 24 V DC ±10 %						Ripple P-P 10 % or less	
Power consumption	<Red LED / Infrared LED type> Normal operation: 960 mW or less (Current consumption 40 mA or less at 24 V supply voltage) ECO mode: 600 mW or less (Current consumption 25 mA or less at 24 V supply voltage)				<Blue LED / Green LED type> Normal operation: 720 mW or less (Current consumption 30 mA or less at 24 V supply voltage) ECO mode: 430 mW or less (Current consumption 18 mA or less at 24 V supply voltage)			
Output	<NPN output type> NPN open-collector transistor • Maximum sink current: 100 mA (50 mA, if five, or more, amplifiers are connected in cascade.) • Applied voltage: 30 V DC or less (between output and 0 V) • Residual voltage: 1.5 V or less [at 100 mA (at 50 mA, if five, or more, amplifiers are connected in cascade) sink current.]				<NPN output type> NPN open-collector transistor 2 outputs • Maximum sink current: 50 mA each (Note 2) • Applied voltage: 30 V DC or less (between output and 0 V) • Residual voltage: 1.5 V or less [at 50 mA (Note 2)]			
	<PNP output type> PNP open-collector transistor • Maximum source current: 100 mA (50 mA, if five, or more, amplifiers are connected in cascade.) • Applied voltage: 30 V DC or less (between output and +V) • Residual voltage: 1.5 V or less [at 100 mA (at 50 mA, if five, or more, amplifiers are connected in cascade) source current.]				<PNP output type> PNP open-collector transistor 2 outputs • Maximum source current: 50 mA each (Note 2) • Applied voltage: 30 V DC or less (between output and +V) • Residual voltage: 1.5 V or less [at 50 mA (Note 2)]			
Output operation	Selectable either Light-ON or Dark-ON, with jog switch							
Short-circuit protection	Incorporated							
Response time	65 μs or less [H-SP (Red LED type only)], 150 μs or less (FAST), 250 μs or less [STD / S-D (Red LED type only)], 2 ms or less (LONG), selectable with jog switch				35 μs or less (H-SP), 150 μs or less (FAST), 250 μs or less (STD / S-D), 2 ms or less (LONG), selectable with jog switch		65 μs or less (H-SP), 150 μs or less (FAST), 250 μs or less (STD), 700 μs or less (STDF), 2.5 ms or less (LONG), 4.5 ms or less (U-LG), selectable with jog switch	
Sensitivity setting	2-point teaching / Limit teaching / Manual adjustment / Full-auto teaching / Max. sensitivity teaching						Normal mode: 2-point teaching / Limit teaching / Full-auto teaching / Max. sensitivity teaching / Manual adjustment Window comparator mode: Teaching (1-point / 2-point / 3-point) / Manual adjustment	
Operation indicator	Orange LED (lights up when the output is ON)							
Stability indicator	Green LED (lights up under stable light received condition or stable dark condition)							
MODE indicator	RUN: Green LED, TEACH • ADJ • L/D ON • TIMER • PRO: Yellow LED							
Digital display	4 digit red LED display							
Fine sensitivity adjustment function	Incorporated							
Timer function	Incorporated with variable ON-delay / OFF-delay / ONE SHOT timer, switchable either effective or ineffective. [Timer period: Red LED type; 0.5 ms approx., 1 to 9,999 ms (Blue LED, Green LED, Infrared LED type; approx. 0.5 to 500 ms)]				Incorporated with variable ON-delay / OFF-delay / ONE SHOT / ON-delay • OFF-delay / ON-delay • ONE SHOT timer, switchable either effective or ineffective. (Timer period: Output 1; 0.5 ms, 1 to 9,999 ms, Output 2; 0.5 ms, 1 to 500 ms)			
Light emitting amount selection function	Incorporated (Red LED type only) (Note 3) FAST, STD, LONG: 4 level, H-SP: 3 level, S-D: 2 level				Incorporated (Note 3) FAST, STD, LONG: 4 level H-SP, S-D: 2 level		Incorporated (Note 3) FAST, STD, STDF, LONG, U-LG: 4 level H-SP: 3 level	
Automatic interference prevention function	Incorporated (Up to four sets of fiber heads can be mounted close together. However, 2 fiber heads in H-SP mode.) (Note 4)				—		Incorporated [Up to four sets of fiber heads can be mounted close together. (However, 8 fiber heads in U-LG mode, 2 fiber heads in H-SP mode.)] (Note 5)	
Environmental resistance	Ambient temperature	-10 to +55 °C +14 to +131 °F (If 4 to 7 units are connected in cascade: -10 to +50 °C +14 to +122 °F, if 8 to 16 units are connected in cascade: -10 to +45 °C +14 to +113 °F) (No dew condensation or icing allowed), Storage: -20 to +70 °C -4 to +158 °F						
	Ambient humidity	35 to 85 % RH, Storage: 35 to 85 % RH						
	Ambient illuminance	Incandescent light: 3,000 lx at the light-receiving face						
	Voltage withstandability	1,000 V AC for one min. between all supply terminals connected together and enclosure (Note 6)						
	Insulation resistance	20 MΩ, or more, with 250 V DC megger between all supply terminals connected together and enclosure (Note 6)						
	Vibration resistance	10 to 150 Hz frequency, 0.75 mm 0.030 in amplitude in X, Y and Z directions for two hours each						
	Shock resistance	98 m/s ² acceleration (10 G approx.) in X, Y and Z directions for five times each						
FX-500	Emitting element (modulated)	Red LED	Blue LED	Green LED	Infrared LED	Red LED	Red LED	
FX-300	Peak emission wavelength	650 nm 0.026 mil	470 nm 0.019 mil	525 nm 0.021 mil	940 nm 0.037 mil	650 nm 0.026 mil	650 nm 0.026 mil	
FX-410	Material	Enclosure: Heat-resistant ABS, Case cover: Polycarbonate, MODE key: Acrylic, Jog switch: Heat-resistant ABS (FX-301B/G/H: Acrylic)						
FX-311	Connecting method	Connector (Note 7)						
FX-301-F7 / FX-301-F	Cable length	Total length up to 100 m 328.084 ft (50 m 164.042 ft for 5 to 8 units, 20 m 65.617 ft for 9 to 16 units) is possible with 0.3 mm ² , or more, cable.						
	Weight	Net weight: 20 g approx., Gross weight: 25 g approx.						
	Accessory	FX-MB1 (amplifier protection seal): 1 set				FX-MB1 (amplifier protection seal): 1 set		

- Notes: 1) Where measurement conditions have not been specified precisely, the conditions used were an ambient temperature of +23 °C +73.4 °F.
 2) 50 mA per output. 25 mA if five, or more, amplifiers are connected in cascade.
 3) The light emitting amount can be zero (emission halt) in all modes.
 4) When the power supply is switched on, the light emission timing is automatically set for interference prevention.
 5) When the interference prevention function "IP-2" is set, the number of mountable fiber heads becomes double.
 Furthermore, take care that the response time also becomes double.
 6) The voltage withstandability and the insulation resistance values given in the above table are for the amplifier only.
 7) The cable for amplifier connection is not supplied as an accessory. Make sure to use the optional quick-connection cables given below.
 Main cable (3-core) for FX-301(P)(-HS): CN-73-C1 (Cable length 1 m 3.281 ft), CN-73-C2 (Cable length 2 m 6.562 ft), CN-73-C5 (Cable length 5 m 16.404 ft)
 Sub cable (1-core) for FX-301(P)(-HS): CN-71-C1 (Cable length 1 m 3.281 ft), CN-71-C2 (Cable length 2 m 6.562 ft), CN-71-C5 (Cable length 5 m 16.404 ft)
 Main cable (4-core) for FX-305(P): CN-74-C1 (Cable length 1 m 3.281 ft), CN-74-C2 (Cable length 2 m 6.562 ft), CN-74-C5 (Cable length 5 m 16.404 ft)
 Sub cable (2-core) for FX-305(P): CN-72-C1 (Cable length 1 m 3.281 ft), CN-72-C2 (Cable length 2 m 6.562 ft), CN-72-C5 (Cable length 5 m 16.404 ft)

I/O CIRCUIT AND WIRING DIAGRAMS

FX-301(-HS)

NPN output type

I/O circuit diagram

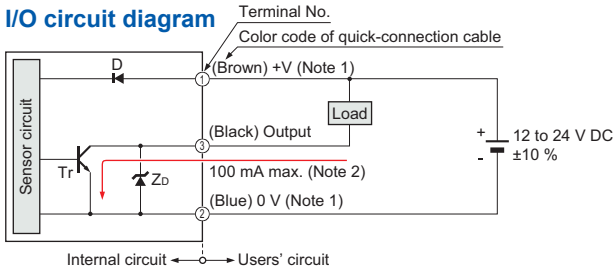

Notes: 1) The quick-connection sub cable does not have +V (brown) and 0 V (blue). The power is supplied from the connector of the main cable.
2) 50 mA max., if five amplifiers, or more, are connected together.

Symbols ... D : Reverse supply polarity protection diode
Zd : Surge absorption zener diode
Tr : NPN output transistor

Wiring diagram

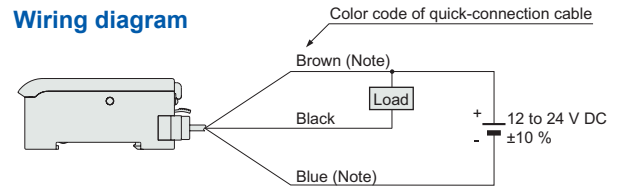

Note: The quick-connection sub cable does not have brown lead wire and blue lead wire.

Terminal arrangement diagram

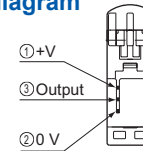

FX-301P(-HS)

PNP output type

I/O circuit diagram

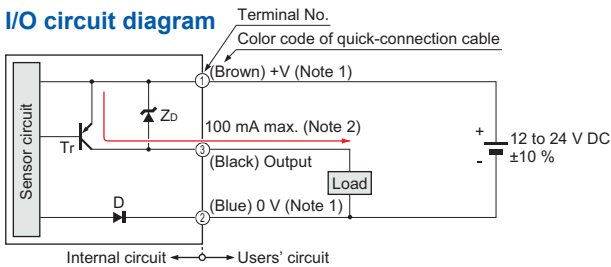

Notes: 1) The quick-connection sub cable does not have +V (brown) and 0 V (blue). The power is supplied from the connector of the main cable.
2) 50 mA max., if five amplifiers, or more, are connected together.

Symbols ... D : Reverse supply polarity protection diode
Zd : Surge absorption zener diode
Tr : PNP output transistor

Wiring diagram

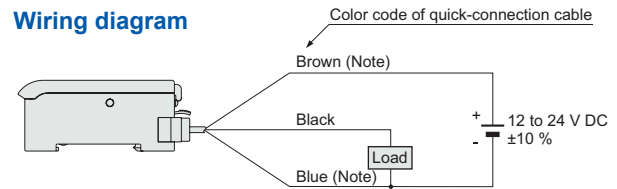

Note: The quick-connection sub cable does not have brown lead wire and blue lead wire.

Terminal arrangement diagram

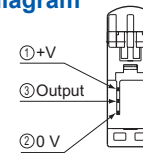

FX-305

NPN output type

I/O circuit diagram

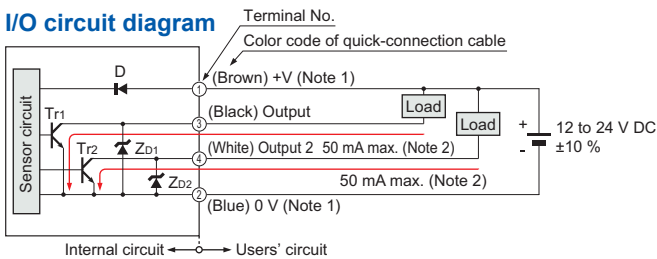

Notes: 1) The quick-connection sub cable does not have +V (brown) and 0 V (blue). The power is supplied from the connector of the main cable.
2) 25 mA max., if five amplifiers, or more, are connected together.

Symbols ... D: Reverse supply polarity protection diode
ZD1, ZD2: Surge absorption zener diode
Tr1, Tr2 : NPN output transistor

Wiring diagram

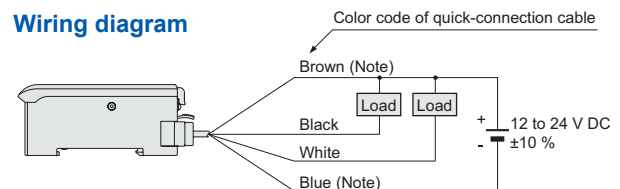

Note: The quick-connection sub cable does not have brown lead wire and blue lead wire.

Terminal arrangement diagram

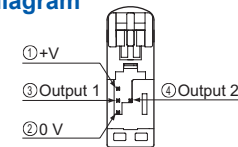

FX-305P

PNP output type

I/O circuit diagram

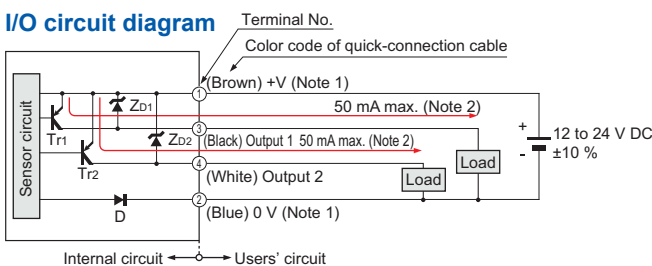

Notes: 1) The quick-connection sub cable does not have +V (brown) and 0 V (blue). The power is supplied from the connector of the main cable.
2) 25 mA max., if five amplifiers, or more, are connected together.

Symbols ... D: Reverse supply polarity protection diode
ZD1, ZD2: Surge absorption zener diode
Tr1, Tr2 : PNP output transistor

Wiring diagram

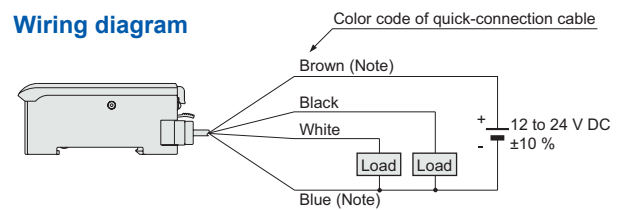

Note: The quick-connection sub cable does not have brown lead wire and blue lead wire.

Terminal arrangement diagram

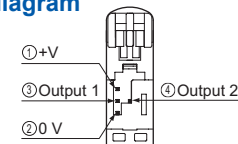

FIBER SENSORS

LASER SENSORS

PHOTO-ELECTRIC SENSORS

MICRO PHOTO-ELECTRIC SENSORS

AREA SENSORS

LIGHT CURTAINS / SAFETY COMPONENTS

PRESSURE / FLOW SENSORS

INDUCTIVE PROXIMITY SENSORS

PARTICULAR USE SENSORS

SENSOR OPTIONS

SIMPLE WIRE-SAVING UNITS

WIRE-SAVING SYSTEMS

MEASUREMENT SENSORS

STATIC ELECTRICITY PREVENTION DEVICES

LASER MARKERS

PLC

HUMAN MACHINE INTERFACES

ENERGY CONSUMPTION VISUALIZATION COMPONENTS

FA COMPONENTS

MACHINE VISION SYSTEMS

UV CURING SYSTEMS

Selection Guide

Fibers

Fiber Amplifiers

FX-500

FX-100

FX-300

FX-410

FX-311

FX-301-F7/ FX-301-F

PRECAUTIONS FOR PROPER USE

Refer to p.1458~ for general precautions and to the "PRO mode operation guide" on our website for details pertaining to operating instructions for the amplifier.



- Never use this product as a sensing device for personnel protection.
- In case of using sensing devices for personnel protection, use products which meet laws and standards, such as OSHA, ANSI or IEC etc., for personnel protection applicable in each region or country.

- The digital fiber sensor **FX-301(P)** has been modified since its production in June 2004. The explanations below are about the modified product.

Mounting

How to mount the amplifier

- ① Fit the rear part of the mounting section of the amplifier on a 35 mm **1.378 in** width DIN rail.
- ② Press down the rear part of the mounting section of the unit on the 35 mm **1.378 in** width DIN rail and fit the front part of the mounting section to the 35 mm **1.378 in** width DIN rail.

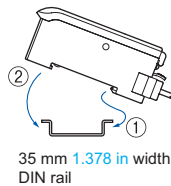

How to remove the amplifier

- ① Push the amplifier forward.
- ② Lift up the front part of the amplifier to remove it.

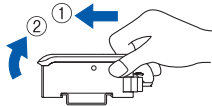

Note: Take care that if the front part is lifted without pushing the amplifier forward, the hook on the rear portion of the mounting section is likely to break.

Fiber installation

- Insert the fiber into the amplifier after attaching the attachment. Refer to the "Instruction Manual" included with the fiber for details.

- ① Push the fiber lock lever down.
- ② Slowly insert the fiber into the insertion slot until it stops. (Note 1)
- ③ Push the fiber lock lever back up until it stops.

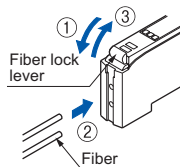

Notes: 1) Note that if the fiber is not fully inserted, the sensing distance will decrease. Also note that the flexible fiber may bend during insertion.
2) In case of coaxial reflective type fibers (**FD-G4**, **FD-FM2**, etc.), mount the central fiber (single-core) to the emitter part and the peripheral fiber (multi-core) to the receiver. Note that sensing precision will deteriorate when done in reverse.

Connection

- Make sure that the power supply is off while connecting or disconnecting the quick-connection cable.

Connection method

- ① Holding the connector of the quick-connection cable, align its projection with the groove at the top portion of the amplifier connector.
- ② Insert the connector till a click is felt.

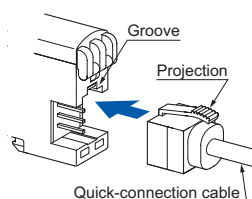

Disconnection method

- ① Pressing the projection at the top of the quick-connection cable, pull out the connector.

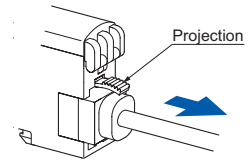

Note: Take care that if the connector is pulled out without pressing the projection, the projection may break. Do not use a quick-connection cable whose projection has broken. Further, do not pull by holding the cable, as this can cause a cable-break.

Cascading

- Make sure that the power supply is off while adding or removing the amplifiers.
- Make sure to check the allowable ambient temperature, as it depends on the number of amplifiers connected in cascade.
- In case two, or more, amplifiers are connected in cascade, make sure to mount them on a DIN rail.
- When the amplifiers move on the DIN rail depending on the attaching condition or the amplifiers are mounted close to each other in cascade, fit them between the optional end plates (**MS-DIN-E**) mounted at the two ends.
- Up to maximum 15 amplifiers can be added (total 16 amplifiers connected in cascade.)
- When connecting more than two amplifiers in cascade, use the sub cable (**CN-71-C□** / **CN-72-C□**) as the quick-connection cable for the second amplifier onwards.
- When connecting amplifiers not close to each other in parallel, be sure to mount the optional end plate (**MS-DIN-E**) at both sides of each amplifier or affix the communication window seal of the accessory amplifier protection seal (**FX-MB1**) to the communication windows.
- The settings other than the interference prevention function cannot be transmitted between **FX-301(P)**, **FX-301B/G/H(P)**, **FX-305(P)**. Therefore, in case both models of amplifiers are mounted in cascade, be sure to mount identical models together. However, the interference prevention function is not incorporated in the **FX-301(P)-HS**. Take care when the sensors are mounted in cascade.
- If the **FX-301(P)** updated version unit or the **FX-305(P)** is mounted with the **FX-301(P)** previous version unit or the **FX-301B/G/H(P)** in cascade, place the **FX-301(P)** updated version units and the **FX-305(P)** units to the right side (seen from the connector side) of the previous version units. For details, refer to "**Cautions on sensor connection in cascade**".
For a difference between the updated version unit and the previous version unit, refer to "**A difference between the updated version unit and the previous version unit**".
- The communication function of this product and that of the **FX-301(P)-F / F7** is different. If these models are mounted in cascade, affix the accessory fiber amplifier protection seal (**FX-MB1**) included in the **FX-301(P)** and **FX-305(P)** to the communication windows of the amplifiers.

PRECAUTIONS FOR PROPER USE

Refer to p.1458~ for general precautions and to the "PRO mode operation guide" on our website for details pertaining to operating instructions for the amplifier.

Cascading method

- Mount the amplifiers, one by one, on the 35 mm 1.378 in width DIN rail.
- Slide the amplifiers next to each other, and connect the quick-connection cables.
- Mount the optional end plates (**MS-DIN-E**) at both the ends to hold the amplifiers between their flat sides.
- Tighten the screws to fix the end plates.

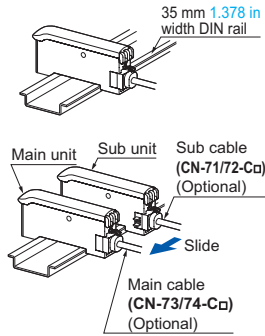

Dismantling

- Loosen the screws of the end plates.
- Remove the end plates.
- Slide the amplifiers and remove them one by one.

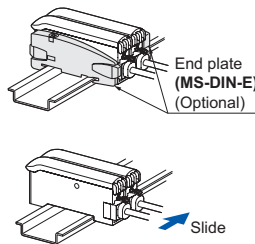

Cautions on sensor connection in cascade

- When the units in the group A and the group B shown in the table below are connected in cascade, connect them in cascade as **<Figure A>** shown below.

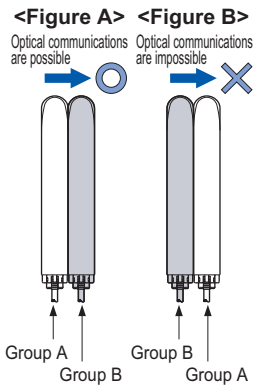

Group A	FX-301(P): Previous version unit (Note 1), FX-301G(P)/B(P)/H(P), FX-41□(P), LS-401(P) (Note 2)
Group B	FX-301(P): Updated version unit (Note 1), FX-305(P)

Notes: 1) For the difference between the updated version unit and the previous version unit, refer to "A difference between the updated version unit and the previous version unit".
 2) When LS-401(P) is connected with the digital fiber amplifier in cascade, be sure to locate LS-401(P) at the left-most position (when viewed from the connector side).

- When the units of the group A and the group B are connected in cascade as **<Figure B>** shown above, optical communications cannot be done. When the optical communications function is used, connect them as **<Figure A>** shown above. If the units cannot be placed as **<Figure A>**, the following measure ① or ② should be taken.

- Affix the communication window seal of the accessory fiber amplifier protection seal (**FX-MB1**) to the communication window of the **FX-301(P)** updated version unit or **FX-305(P)**.
- If the measure ① described above cannot be taken, change the optical communications spec. of the group B units.

How to change the communication specification of Group B

- Change the communication specification of Group B according to the following procedures. Make sure to set the communication specification to "3" (Group A communication specification)" or "0" (Optical Communication Stop)".

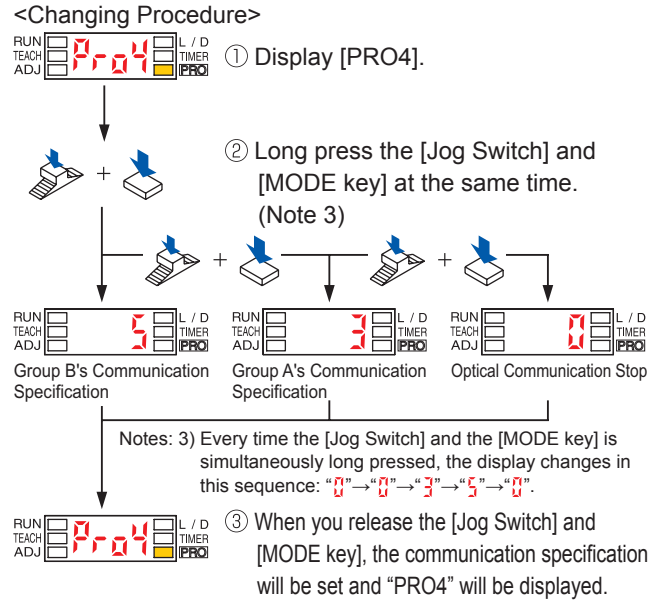

Notes: 3) Every time the [Jog Switch] and the [MODE key] is simultaneously long pressed, the display changes in this sequence: "0" → "1" → "3" → "5" → "0".
 Notes: 4) When the communication specification is set to "3" (Group A communication specification)", make sure to tightly attach the products. Also make sure to take note of the following:
 • There are instances when the optical communication function cannot be used due to the usage environment, etc.
 • Do not perform batch channel loading or saving.

Part description

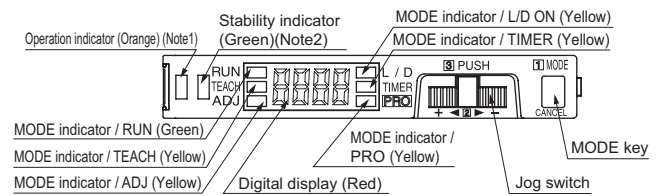

Notes: 1) **FX-305(P)**; Output 1 operation indicator (Orange)
 2) **FX-305(P)**; Output 2 operation indicator (Orange)

Operation procedure

- When the power supply is switched on, communication self-check is carried out and normal condition is displayed [MODE indicator / RUN (green)] lights up and the digital display shows the incident light intensity.
- When the MODE key is pressed, the mode will change as shown in the following diagram.

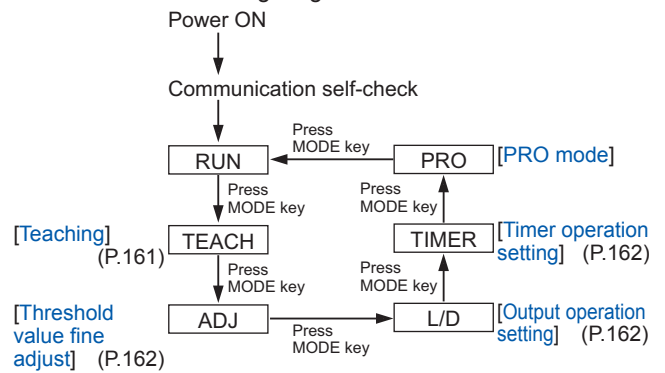

When Jog switch is pressed, the setting is confirmed. When MODE key is pressed for 2 sec., or more, the sensor returns to the 'RUN' mode. Cancellation is possible by pressing MODE key during setting.

FIBER SENSORS

LASER SENSORS

PHOTO-ELECTRIC SENSORS

MICRO PHOTO-ELECTRIC SENSORS

AREA SENSORS

LIGHT CURTAINS / SAFETY COMPONENTS

PRESSURE / FLOW SENSORS

INDUCTIVE PROXIMITY SENSORS

PARTICULAR USE SENSORS

SENSOR OPTIONS

SMALL WIRE-SAVING UNITS

WIRE-SAVING SYSTEMS

MEASUREMENT SENSORS

STATIC ELECTRICITY PREVENTION DEVICES

LASER MARKERS

PLC

HUMAN MACHINE INTERFACES

ENERGY CONSUMPTION VISUALIZATION COMPONENTS

FA COMPONENTS

MACHINE VISION SYSTEMS

UV CURING SYSTEMS

Selection Guide

Fibers

Fiber Amplifiers

FX-500

FX-100

FX-300

FX-410

FX-311

FX-301-F7/ FX-301-F

- FIBER SENSORS
- LASER SENSORS
- PHOTO-ELECTRIC SENSORS
- MICRO PHOTO-ELECTRIC SENSORS
- AREA SENSORS
- LIGHT CURTAINS / SAFETY COMPONENTS
- PRESSURE / FLOW SENSORS
- INDUCTIVE PROXIMITY SENSORS
- PARTICULAR USE SENSORS
- SENSOR OPTIONS
- WIRE-SAVING UNITS
- WIRE-SAVING SYSTEMS
- MEASUREMENT SENSORS
- STATIC ELECTRICITY PREVENTION DEVICES
- LASER MARKERS
- PLC
- HUMAN MACHINE INTERFACES
- ENERGY CONSUMPTION VISUALIZATION COMPONENTS
- FA COMPONENTS
- MACHINE VISION SYSTEMS
- UV CURING SYSTEMS
- Selection Guide
- Fibers
- Fiber Amplifiers
- FX-500
- FX-100
- FX-300
- FX-410
- FX-311
- FX-301-F7 / FX-301-F

PRECAUTIONS FOR PROPER USE

Refer to p.1458~ for general precautions and to the "PRO mode operation guide" on our website for details pertaining to operating instructions for the amplifier.

For FX-305(P)

The **FX-305(P)** is equipped with two independent outputs, but the items that can be set in output 1 and output 2 respectively are only the following.

The items other than those are common.

- ① Threshold value
- ② Output operation
- ③ Timer operation and Timer period
- ④ Sensing mode

Teaching

- The threshold values can be set by 2-point teaching, limit teaching, full-auto teaching or window comparator mode (1-point, 2-point, 3-point teaching) [only for **FX-305(P)**], when the MODE indicator / TEACH (yellow) lights up.

In case of 2-point teaching

- This is the method of setting the threshold value by teaching two levels, corresponding to the object present and object absent conditions. Normally, setting is done by this method.

Step	Description	Display
①	Set the fiber within the sensing range. Press MODE key to light up MODE indicator / TEACH (yellow).	
②	For FX-305(P) , select either Output 1 "Out 1" or Output 2 "Out 2" beforehand, press jog switch in the object present condition. If the teaching is accepted, the read incident light intensity blinks in the digital display. 	
③	MODE indicator / TEACH (yellow) blinks. Press jog switch in the object absent condition. 	
④	If the teaching is accepted, the read incident light intensity blinks in the digital display and the threshold value is set at the mid-value between the incident light intensities in the object present and the object absent conditions. After this, the judgment on the stability of sensing is displayed. • In case stable sensing is possible: "Good" is displayed. • In case stable sensing is not possible: "Bad" blinks.	
⑤	The threshold value is displayed.	
⑥	"...." blinks in the digital display. (only FX-301B/G/H)	
⑦	The incident light intensity appears in the digital display and the setting is complete.	

- Notes: 1) Do not move or bend the fiber cable after the sensitivity setting. Detection may become unstable.
2) In case a reflective-type fiber is used, maximum sensitivity will be set if the jog switch is pushed while in no work status in procedure ② and ③.

In case of full auto-teaching

- Full auto-teaching is used when it is desired to set the threshold value without stopping the assembly line, with the object in the moving condition.

Step	Description	Display
①	Set the fiber within the sensing range. Press MODE key to light up MODE indicator / TEACH (yellow).	
②	For FX-305(P) , select either Output 1 "Out 1" or Output 2 "Out 2" beforehand, press the jog switch continuously for 0.5 sec. or more with the object moving on the assembly line. (The incident light intensity is displayed during sampling.)	
③	"Auto" is displayed on the digital display. Release the jog switch when the object has passed.	
④	If the teaching is accepted, the read incident light intensity blinks in the digital display and the threshold value is set at the mid-value between the incident light intensities in the object present and the object absent conditions. After this, the judgment on the stability of sensing is displayed. • In case stable sensing is possible: "Good" is displayed. • In case stable sensing is not possible: "Bad" blinks.	
⑤	The threshold value is displayed.	
⑥	"...." blinks in the digital display. (only FX-301B/G/H)	
⑦	The incident light intensity appears in the digital display and the setting is complete.	

- Notes: 1) The threshold value's shift amount can be selected in PRO mode. Refer to the "PRO Mode Operation Guide" for more details pertaining to setting instructions. (Increments of 5 % between -45 and 45 % for setting possible. 0 % default.)
2) Do not move or bend the fiber cable after the sensitivity setting. Detection may become unstable.

PRECAUTIONS FOR PROPER USE

Refer to p.1458~ for general precautions and to the "PRO mode operation guide" on our website for details pertaining to operating instructions for the amplifier.

In case of limit teaching

- This is the method of setting the threshold value by teaching only the object absent condition (stable incident light condition). This is used for detection in the presence of a background body or for detection of small objects.

Step	Description	Display
①	Set the fiber within the sensing range. Press MODE key to light up MODE indicator / TEACH (yellow).	
②	For FX-305(P) , select either Output 1 "Out1" or Output 2 "Out2" beforehand, press jog switch in the object absent condition. If the teaching is accepted, the read incident light intensity blinks in the display. <div style="display: flex; justify-content: space-around;"> <div style="text-align: center;"> <p>Thru-beam type</p> </div> <div style="text-align: center;"> <p>Reflective type</p> </div> </div> <p>Beam incident condition</p>	
③	MODE indicator / TEACH (yellow) blinks. Turn jog switch to the "+" side or "-" side.	
④	If jog switch is turned to the "+" side, " " scrolls (twice) the display from right to left (Note 1), and the threshold level is shifted to a value approx. 15 % higher (lower sensitivity) than that set at ②. (Note 2) This is used in case of reflective type fibers. If jog switch is turned to the "-" side, " " scrolls (twice) the display from left to right, and the threshold level is shifted to a value approx. 15 % lower (higher sensitivity) than that set at ②. (Note 2) This is used in case of thru-beam type fibers. 	
⑤	After this, the judgment on whether the setting shift amount can be shifted or not is displayed. • In case shifting is possible: "Good" blinks. • In case shifting is not possible: "Err" blinks.	
⑥	The threshold value is displayed.	
⑦	" " blinks in the digital display. (only FX-301B/G/H)	
⑧	The incident light intensity appears in the digital display and the setting is complete.	

- Notes: 1) Scrolling display is not available in **FX-301B/G/H**.
 2) The approx. 15 % amount of shift is the initial value. The amount of shift can be changed in the PRO mode from approx. 5 to 80 % (5 % step). Refer to the "PRO Mode Operation Guide" for more details pertaining to setting instructions.
 3) Do not move or bend the fiber cable after the sensitivity setting. Detection may become unstable.

Please download the instruction manual from our website for setting of threshold value when used in combination with liquid level sensing fiber **FD-F8Y** and with pipe-mountable liquid level sensing fiber **FD-F4**.

For the wind comparator mode teaching in **FX-305(P)**, refer to the separately prepared "PRO Mode Operation Guide".

Threshold value fine adjustment

Step	Description	Display
①	Press MODE key to light up MODE indicator / ADJ (yellow).	
②	For FX-305(P) , select either Output 1 "Out1" or Output 2 "Out2" beforehand, in case the threshold value is to be increased (sensitivity to be reduced), turn the jog switch to the "+" side to increase the threshold value slowly. If the jog switch is turned continuously to the "+" side, the threshold value increases rapidly. In case the threshold value is to be decreased (sensitivity to be increased), turn the jog switch to the "-" side to decrease the threshold value slowly. If the jog switch is turned continuously to the "-" side, the threshold value decreases rapidly.	 ↓ or ↓
③	When jog switch is pressed, the threshold value is confirmed.	

Output operation setting

Step	Description	Display
①	Press MODE key to light up MODE indicator / L/D ON (yellow).	 Displays present setting
②	For FX-305(P) , select either Output 1 "Out1" or Output 2 "Out2" beforehand, if the jog switch is turn to the "+" or "-" direction, the output operation setting will change. 	Light state ↓ Dark state
③	When jog switch is pressed, the threshold value is confirmed.	 Displays selected setting

Timer operation setting

- The setting for whether the timer is used or not can be done when MODE indicator / TIMER (yellow) lights up. For **FX-301B/G/H**, the timer type can be set in PRO mode.
- Further, an OFF-delay (initial value) which is useful when the response of the connected device is slow, etc., an ON-delay which is useful to detect only objects taking a long time to travel, and ONE SHOT, which is useful when the input specifications of the connected device require a signal of a fixed width, are possible with the **FX-301(-HS)**. **FX-305(P)** is also equipped with ON-delay • OFF-delay and ON-delay • ONE SHOT timers. Refer to the "PRO Mode Operation Guide" for the setting method of the OFF-delay, ON-delay and ONE SHOT timer intervals.

FIBER SENSORS

LASER SENSORS

PHOTO-ELECTRIC SENSORS

MICRO PHOTO-ELECTRIC SENSORS

AREA SENSORS

LIGHT CURTAINS / SAFETY COMPONENTS

PRESSURE / FLOW SENSORS

INDUCTIVE PROXIMITY SENSORS

PARTICULAR USE SENSORS

SENSOR OPTIONS

SIMPLE WIRE-SAVING UNITS

WIRE-SAVING SYSTEMS

MEASUREMENT SENSORS

STATIC ELECTRICITY PREVENTION DEVICES

LASER MARKERS

PLC

HUMAN MACHINE INTERFACES

ENERGY CONSUMPTION VISUALIZATION COMPONENTS

FA COMPONENTS

MACHINE VISION SYSTEMS

UV CURING SYSTEMS

Selection Guide

Fibers

Fiber Amplifiers

FX-500

FX-100

FX-300

FX-410

FX-311

FX-301-F7/ FX-301-F

PRECAUTIONS FOR PROPER USE

Refer to p.1458~ for general precautions and to the "PRO mode operation guide" on our website for details pertaining to operating instructions for the amplifier.

Wiring

- Make sure that the power supply is off while wiring.
- Verify that the supply voltage variation is within the rating.
- Take care that if a voltage exceeding the rated range is applied, or if an AC power supply is directly connected, the product may get burnt or damaged.
- If power is supplied from a commercial switching regulator, ensure that the frame ground (F.G.) terminal of the power supply is connected to an actual ground.
- In case noise generating equipment (switching regulator, inverter motor, etc.) is used in the vicinity of this product, connect the frame ground (F.G.) terminal of the equipment to an actual ground.
- Take care that short circuit of the load wrong wiring may burn or damage the product.
- Do not run the wires together with high-voltage lines or power lines or put them in the same raceway. This can cause malfunction due to induction.
- Make sure to use an isolation transformer for the DC power supply. If an autotransformer (single winding transformer) is used, this product or the power supply may get damaged.
- Make sure to use the optional quick-connection cable for the connection of the amplifier. Extension up to total 100 m **328.084 ft** is possible with 0.3 mm², or more, cable. (5-8 unit expansion: 50 m **164.042 ft**, 9-16 unit expansion: 20 m **65.617 ft**) However, in order to reduce noise, make the wiring as short as possible.
- Note that the residual voltage will increase when the cable is extended.

Key-lock function

- If jog switch and MODE key are pressed for more than 2 sec. at the same time in 'RUN' mode condition, the key operations are locked, and only the threshold value confirmation function or the adjust function (valid only when the adjust lock function is canceled) is valid. To cancel the lock function, press both the keys for more than 2 sec. once again.

Note: 3 seconds or more for **FX-301B/G/H(P)**.

Others

- When the emission halt of the light emitting amount selection function is set from "OFF" to "ON", the output may be unstable. Do not use the output control for 0.5 sec. after starting emission.
- Do not use during the initial transient time (0.5 sec.) after the power supply is switched on.
- Take care that the sensor is not directly exposed to fluorescent lamp from a rapid-starter lamp, a high frequency lighting device or sunlight etc., as it may affect the sensing performance.
- Do not use this sensor in places having excessive vapor, dust, etc., or where it may come in contact with corrosive gas.
- Take care that the product does not come in direct contact with water, oil, grease, or organic solvents, such as, thinner, etc.
- This sensor cannot be used in an environment containing inflammable or explosive gases.
- Never disassemble or modify the sensor.

Function table for FX-300 series

	Previous models			New models		
	Standard type	High-function type	High-speed type	Standard type	High-speed type	High-function type
	FX-301(P) (Previous version unit)	FX-302(P)	FX-303(P)	FX-301(P) (Updated version unit)	FX-301(P)-HS	FX-305(P)
Selection Guide	Four-chemical emitting element + APC circuit	No	No	Yes	Yes	Yes
Fibers	Four-chemical emitting element only	Yes (Note)	Yes	Yes	Yes	Yes
Fiber Amplifiers	Light emitting amount selection function	No	No	Yes	Yes	Yes
	Reduced intensity mode (S-D)	Yes (Note)	Yes	Yes	Yes	Yes
	9,999 digit display	No	No	No	No	Yes
FX-500	Response time (Max. speed)	150 μs	300 μs	90 μs	65 μs	35 μs
FX-100	Interference prevention function (Effective no. of units)	Incorporated (4)	Incorporated (8)	Not incorporated (0)	Incorporated (4)	Not incorporated (0)
FX-300	Independent 2 outputs	No	No	No	No	Yes
FX-410	Alarm output function	No	No	No	No	Yes
FX-311	Error output function	No	No	No	No	Yes
FX-301-F7/ FX-301-F	Differential sensing	No	No	No	No	Yes
	Window comparator mode	No	Yes	No	No	Yes

Peripheral units that can be combined

Bank selection unit FX-CH(-P)	Yes	Yes	No	No	No	No
External input unit FX-CH2(-P)	No	No	No	Yes	No	Yes
Upper communication unit SC-GU1-485	No	No	No	Yes	No	Yes

Note: Except **FX-301B/G/H**.

PRECAUTIONS FOR PROPER USE

Refer to p.1458~ for general precautions and to the “PRO mode operation guide” on our website for details pertaining to operating instructions for the amplifier.

A difference between the updated version unit and the previous version unit for FX-301(P) (Red LED type)

- The product has been modified as shown below since its production in June 2004.

Changes in appearance

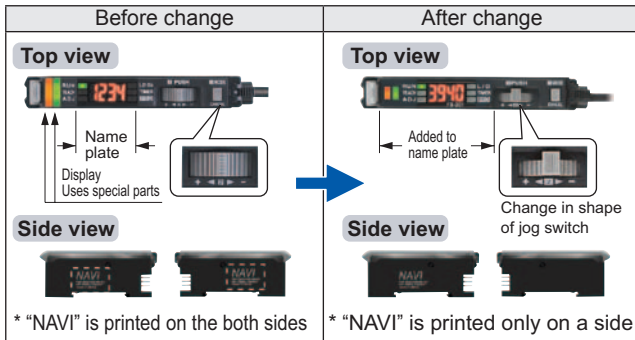

• Checking minor changes between previous and updated models can be done by checking whether the printing is on both sides or only one side.

Upgraded functions

1. Response times added

An ultra high-speed mode (H-SP) has been added to the existing 4 response time modes [high-speed (FAST), reduced intensity (S-D), standard (STD) and long range (LONG)].
This is changed using “Pro1” in “SPEd”

Before change	After change
<p>4 steps</p> 150 μs (FAST) 250 μs (S-D) 250 μs (STD) 2 ms (LONG)	<p>5 steps</p> 65 μs (added) (H-SP) 150 μs (FAST) 250 μs (S-D) 250 μs (STD) 2 ms (LONG)

2. Extension of timer period

The setting range for the timer period was previously 500 ms, but this has been extended to a new range of 9,999 ms.

3. Light emitting amount selection function

The light emitting amount can be changed to one of 4 levels (5 levels when emission halt is included).

4. Backup, copy lock and key lock functions added

- Backup: This selects whether or not threshold values set by teaching are written to (stored in) an EEPROM.
- Copy lock: This selects whether copy function and data bank function communication are possible or not.
- Key lock: This disables input using switches to prevent accidental changing of settings.

Changes in operation

1. Timer selection method

Previous version unit: Timer type was changed using PRO1 mode.
The “TIMER” setting in NAVI mode could only be turned on or off.
After change: The type of timer can be changed using the “TIMER” function in NAVI mode.

2. Checking threshold value in RUN mode

The threshold values can be checked by turning the jog switch.

Display changes

1. Checking blinking of sensitivity surplus

The stable surplus display method after teaching has been changed.
Previous version unit: Sensitivity surplus is indicated by the number of blinks of the stability indicator.



2. Initial direct code value changed

The factory default settings for the direct codes have been changed.

Previous version unit 0000 → After change 0004

* The default setting for the timer period is 10 ms, and the direct code for 10 ms is “4”, so this has been changed.

Internal circuit changes

1. Addition of an APC circuit

A four-chemical emitting element which provides stable sensing over long periods has been added, as well as an APC (Auto Power Control) circuit that improves stability during short periods.

Cautions on sensor connection in cascade

When connecting the previous version unit (including FX-301B/G/H) and updated version unit to be used in a cascade, refer to “Cautions on sensor connection in cascade”.

FIBER SENSORS

LASER SENSORS

PHOTO-ELECTRIC SENSORS

MICRO PHOTO-ELECTRIC SENSORS

AREA SENSORS

LIGHT CURTAINS / SAFETY COMPONENTS

PRESSURE / FLOW SENSORS

INDUCTIVE PROXIMITY SENSORS

PARTICULAR USE SENSORS

SENSOR OPTIONS

SIMPLE WIRE-SAVING UNITS

WIRE-SAVING SYSTEMS

MEASUREMENT SENSORS

STATIC ELECTRICITY PREVENTION DEVICES

LASER MARKERS

PLC

HUMAN MACHINE INTERFACES

ENERGY CONSUMPTION VISUALIZATION COMPONENTS

FA COMPONENTS

MACHINE VISION SYSTEMS

UV CURING SYSTEMS

Selection Guide

Fibers

Fiber Amplifiers

FX-500

FX-100

FX-300

FX-410

FX-311

FX-301-F7/ FX-301-F

PRECAUTIONS FOR PROPER USE

Refer to p.1458~ for general precautions and to the "PRO mode operation guide" on our website for details pertaining to operating instructions for the amplifier.

Diagram of functions and settings

The amplifier features and settings are generally classified into two main modes; the "NAVI mode" for items and settings that are frequently reconfigured, and the "PRO mode" that contains more detailed settings.

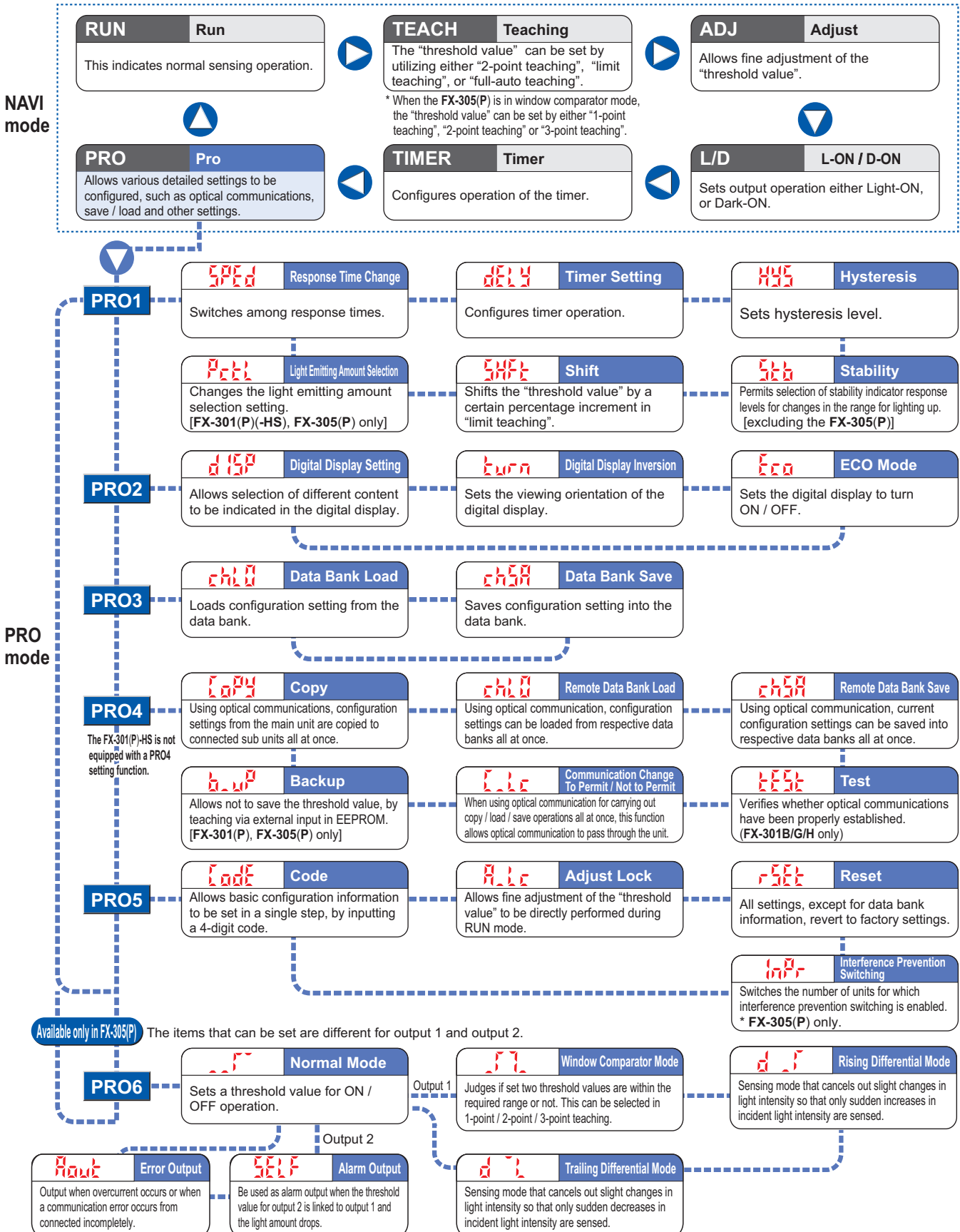

* The 0-ADJ setting function equipped on the FX-301□ and FX-305(P) has been deleted since the production in May 2005.

- FIBER SENSORS
- LASER SENSORS
- PHOTO-ELECTRIC SENSORS
- MICRO PHOTO-ELECTRIC SENSORS
- AREA SENSORS
- LIGHT CURTAINS / SAFETY COMPONENTS
- PRESSURE / FLOW SENSORS
- INDUCTIVE PROXIMITY SENSORS
- PARTICULAR USE SENSORS
- SENSOR OPTIONS
- SIMPLE WIRE-SAVING UNITS
- WIRE-SAVING SYSTEMS
- MEASUREMENT SENSORS
- STATIC ELECTRICITY PREVENTION DEVICES
- LASER MARKERS
- PLC
- HUMAN MACHINE INTERFACES
- ENERGY CONSUMPTION VISUALIZATION COMPONENTS
- FA COMPONENTS
- MACHINE VISION SYSTEMS
- UV CURING SYSTEMS
- Selection Guide
- Fibers
- Fiber Amplifiers
- FX-500
- FX-100
- FX-300
- FX-410
- FX-311
- FX-301-F7 / FX-301-F

DIMENSIONS (Unit: mm in)

The CAD data in the dimensions can be downloaded from our website.

FX-301□ FX-305(P) Amplifier

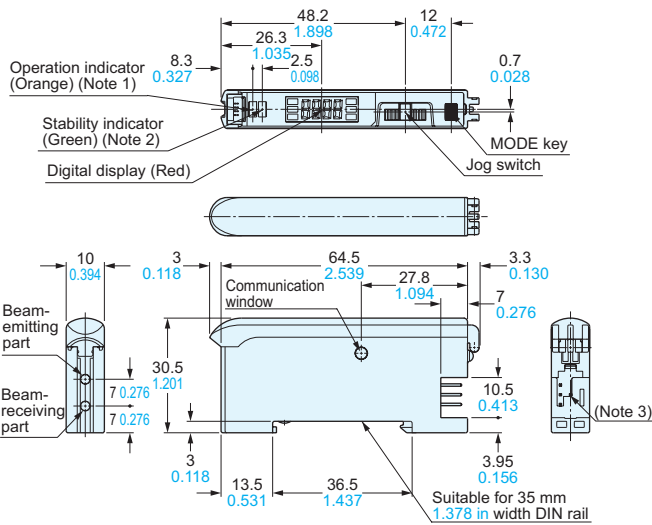

- Notes: 1) **FX-305□**; Output 1 operation indicator (Orange)
- 2) **FX-305□**; Output 2 operation indicator (Orange)
- 3) **FX-301□**; 3-pin, **FX-305□**; 4-pin

CN-73-C□ CN-74-C□ Main cable (Optional)

• Length L

Model No.	Length L
CN-73/74-C1	1,000 39.370
CN-73/74-C2	2,000 78.740
CN-73/74-C5	5,000 196.850

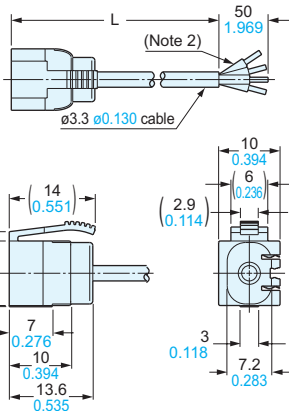

- Notes: 1) **CN-74-C□** only
- 2) **CN-73-C□**; 3-core

CN-71-C□ CN-72-C□ Sub cable (Optional)

• Length L

Model No.	Length L
CN-71/72-C1	1,000 39.370
CN-71/72-C2	2,000 78.740
CN-71/72-C5	5,000 196.850

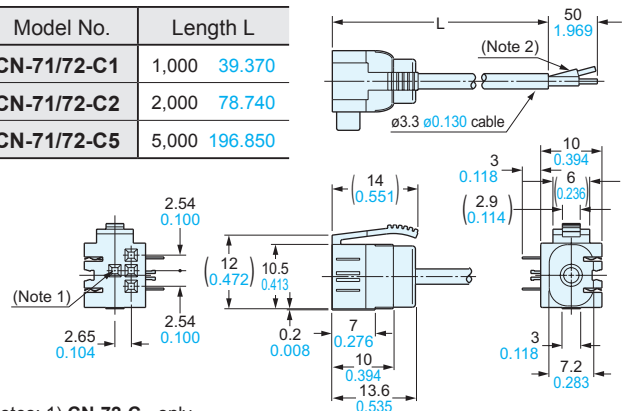

- Notes: 1) **CN-72-C□** only
- 2) **CN-71-C□**; 1-core

MS-DIN-2 Amplifier mounting bracket (Optional)

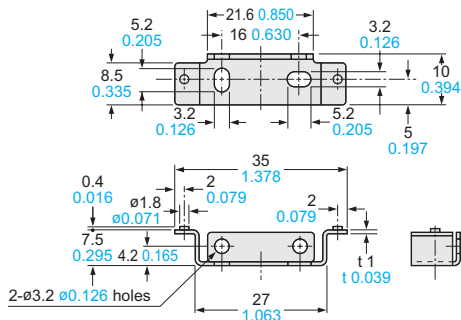

Material: Cold rolled carbon steel (SPCC)
(Uni-chrome plated)

MS-DIN-E End plate (Optional)

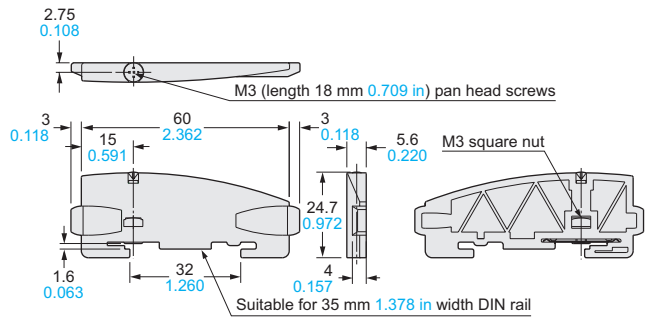

Material: Polycarbonate

FIBER SENSORS

LASER SENSORS

PHOTO-ELECTRIC SENSORS

MICRO PHOTO-ELECTRIC SENSORS

AREA SENSORS

LIGHT CURTAINS / SAFETY COMPONENTS

PRESSURE / FLOW SENSORS

INDUCTIVE PROXIMITY SENSORS

PARTICULAR USE SENSORS

SENSOR OPTIONS

SIMPLE WIRE-SAVING UNITS

WIRE-SAVING SYSTEMS

MEASUREMENT SENSORS

STATIC ELECTRICITY PREVENTION DEVICES

LASER MARKERS

PLC

HUMAN MACHINE INTERFACES

ENERGY CONSUMPTION VISUALIZATION COMPONENTS

FA COMPONENTS

MACHINE VISION SYSTEMS

UV CURING SYSTEMS

Selection Guide

Fibers

Fiber Amplifiers

FX-500

FX-100

FX-300

FX-410

FX-311

FX-301-F7/ FX-301-F