

SERIES D16, P16, L16 SWITCHES

PUSHBUTTON SWITCHES - ILLUMINATED

TACT SWITCHES

NAVIGATION SWITCHES

PUSHBUTTON SWITCHES

TOGGLE SWITCHES

ROCKER SWITCHES

SLIDE SWITCHES

SNAP-ACTION SWITCHES

DIP SWITCHES

KEYLOCK SWITCHES

ROTARY SWITCHES

DETECTOR SWITCHES

CAP OPTIONS



SPECIFICATIONS

Contact Rating:	5A@250 VAC - UL 8A@125 VAC - UL, CSA 6A@24 VDC - UL, CSA
Life Expectancy (Mechanical):	100,000 cycles
Life Expectancy (Electrical):	50,000 cycles
Contact Resistance:	100mΩ max. typical; initial @ 2-4 VDC
Insulation Resistance:	> 1,000MΩ
Dielectric Strength:	> 1,500 volts 1 minute > 3,000 volts between poles
Actuation Force:	300g/pole
Operating Temperature:	-20°C to 55°C

FEATURES & BENEFITS

- ▶ Modular interface/contact block design
- ▶ Robust product for industrial applications
- ▶ Attractive front panel design
- ▶ Illuminated options available

APPLICATIONS/MARKETS

- ▶ Industrial controls
- ▶ Instrumentation
- ▶ Transportation
- ▶ Telecommunications

HOW TO ORDER

SERIES	MECHANICAL CONFIGURATION	PUSHBUTTON HEAD	CIRCUIT	LAMP TYPE & VOLTAGE	LAMP COLOR (WHERE APPLICABLE)	LENS COLOR
D16 = Solder Lug P16 = Socket L16 = Pilot Indicator	EE = Latching OA = Momentary PL* = Pilot Indicator *For L16 (Pilot Indicator)	S1 S2 T1 T2 R* R1 *R (Mushroom Head) Available for D16 & P16 Only.	0* = Pilot Ind. 1**= SPDT 2 = DPDT 3 = 3PDT 4 = 4PDT *For L16 only (Pilot Indicator) **P16 available SPDT only	0 = None A B C F G H J K M N L D E	Red Grn	RED= Red GRN= Green BLU= Blue* WHT= White* ORG= Orange* YEL= Yellow* *Not Available For 'R' Mushroom Head.

▶ ▶ ▶ **Example Ordering Number**
D16-EE-R1-3-A-BLU

Specifications subject to change without notice. 11.16.2021



SERIES D16 SWITCHES

PUSHBUTTON SWITCHES - ILLUMINATED

D16 (SOLDER LUG)

R

MUSHROOM

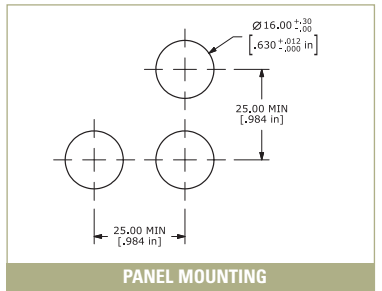

D16 (SOLDER LUG)

R1

ROUND

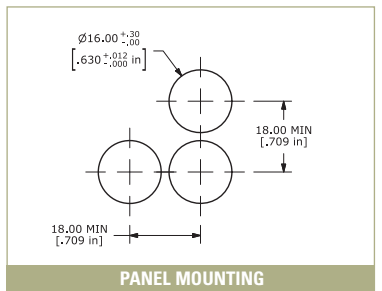
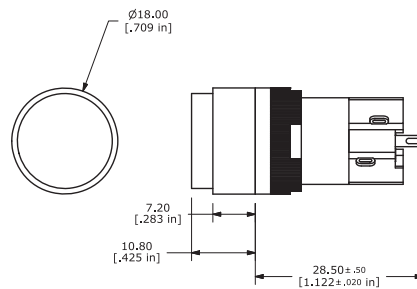

D16 (SOLDER LUG)

S1

SQUARE

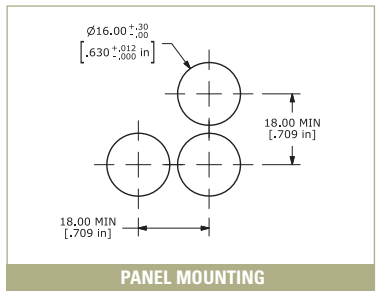
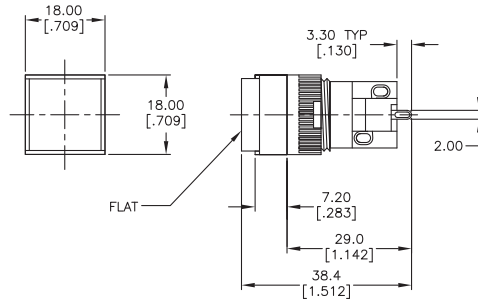

D16 (SOLDER LUG)

T1

RECTANGULAR

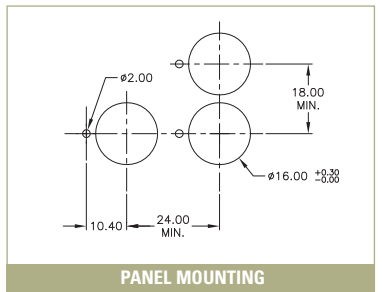

BOTTOM VIEW



SCHEMATIC



MOUNTING LENGTH

	Mounting Length (A)
SPDT	29.0 mm
DPDT	36.5 mm
3PDT	44.0 mm
4PDT	51.5 mm

SERIES P16 SWITCHES

PUSHBUTTON SWITCHES - ILLUMINATED

TACT SWITCHES

NAVIGATION SWITCHES

PUSHBUTTON SWITCHES

TOGGLE SWITCHES

ROCKER SWITCHES

SLIDE SWITCHES

SNAP-ACTION SWITCHES

DIP SWITCHES

KEYLOCK SWITCHES

ROTARY SWITCHES

DETECTOR SWITCHES

CAP OPTIONS

P16 (SOCKET)

R

MUSHROOM



PANEL MOUNTING

P16 (SOCKET)

R1

ROUND



PANEL MOUNTING

P16 (SOCKET)

S1

SQUARE



PANEL MOUNTING

P16 (SOCKET)

T1

RECTANGULAR

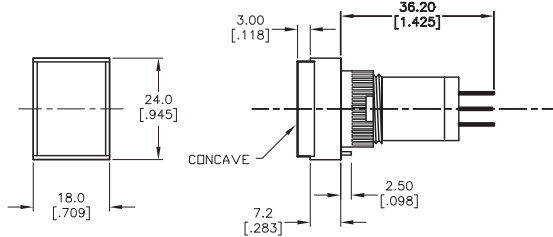

PANEL MOUNTING

BOTTOM VIEW



SCHEMATIC





SERIES L16 SWITCHES

PUSHBUTTON SWITCHES - ILLUMINATED

L16 (PILOT INDICATOR)

R1

ROUND

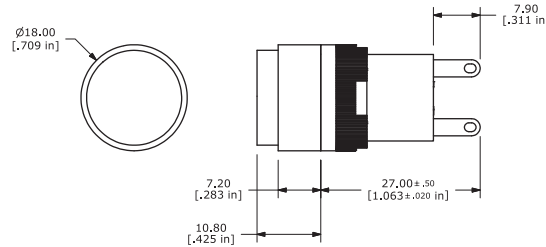

PANEL MOUNTING

L16 (PILOT INDICATOR)

S1

SQUARE



PANEL MOUNTING

L16 (PILOT INDICATOR)

T1

RECTANGULAR



PANEL MOUNTING

BOTTOM VIEW



SCHEMATIC

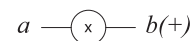

SERIES D16, P16, L16 SWITCHES

PUSHBUTTON SWITCHES - ILLUMINATED

MECHANICAL CONFIGURATION & CIRCUIT OPTIONS

0 PILOT INDICATOR

Available 'L16' Pilot Indicator Type



SCHEMATIC

1 SPDT**

Available for 'P16' Socket Type and 'D16' Solder Lug

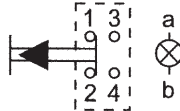

SCHEMATIC

2 DPDT

Available for 'D16' Solder Lug

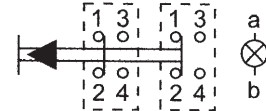

SCHEMATIC

3 3PDT

Available for 'D16' Solder Lug

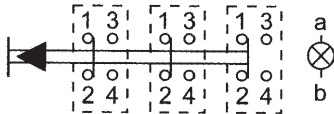

SCHEMATIC

4 4PDT

Available for 'D16' Solder Lug

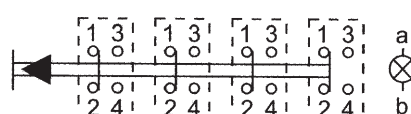

SCHEMATIC

Mechanical Configuration Code

EE	Latching
OA	Momentary
PL	Pilot Indicator*

*L16' Series only

LAMP TYPE & VOLTAGE OPTIONS

ILLUSTRATION	CATEGORY	DESCRIPTION	COLOR	PART NO.
	Incandescent	A = 6V AC/DC 200 mA	Not Applicable	50-004-02
		B = 14V AC/DC 80 mA		50-004-04
		C = 28V AC/DC 40 mA		50-004-05
		D = 48V AC/DC 25 mA		50-004-06
		E = 60V AC/DC 20 mA		50-004-07
		L = 33V AC/DC 35 mA		50-004-08
		N = 14V AC/DC 40 mA		50-004-03
M = 6V AC/DC 40 mA	50-004-01			
	Neon	F = 110V AC	green red	50-004-11 50-004-12
		G = 220V AC	green red	50-004-13 50-004-14
		H = 6V DC	green red yellow	50-004-16 50-004-17 50-004-18
			J = 12V DC	green red yellow
K = 24V DC	green red yellow			50-004-22 50-004-23 50-004-24



ILLUSTRATION		STYLE	SHAPE	COLOR	PART NO.
	Available Color Lens (Acrylic Resin)	Round	Concave	blue green orange red white yellow	50-001-01 50-001-02 50-001-03 50-001-04 50-001-05 50-001-06
		Rectangular	Concave	blue green orange red white yellow	50-002-01 50-002-02 50-002-03 50-002-04 50-002-05 50-002-06
		Square	Concave	blue green orange red white yellow	50-003-01 50-003-02 50-003-03 50-003-04 50-003-05 50-003-06
		Mushroom Head	Convex	green red	50-012-01 50-012-02
		Round	Flat	blue green orange red white yellow	50-001-11 50-001-12 50-001-13 50-001-14 50-001-15 50-001-16
		Rectangular	Flat	blue green orange red white yellow	50-002-11 50-002-12 50-002-13 50-002-14 50-002-15 50-002-16
		Square	Flat	blue green orange red white yellow	50-003-11 50-003-12 50-003-13 50-003-14 50-003-15 50-003-16

TACT SWITCHES

NAVIGATION SWITCHES

PUSHBUTTON SWITCHES

TOGGLE SWITCHES

ROCKER SWITCHES

SLIDE SWITCHES

SNAP-ACTION SWITCHES

DIP SWITCHES

KEYLOCK SWITCHES

ROTARY SWITCHES

DETECTOR SWITCHES

CAP OPTIONS

SERIES D16, P16, L16 SWITCHES

PUSHBUTTON SWITCHES - ILLUMINATED

TACT SWITCHES

NAVIGATION SWITCHES

PUSHBUTTON SWITCHES

TOGGLE SWITCHES

ROCKER SWITCHES

SLIDE SWITCHES

SNAP-ACTION SWITCHES

DIP SWITCHES

KEYLOCK SWITCHES

ROTARY SWITCHES

DETECTOR SWITCHES

CAP OPTIONS

ILLUSTRATION	CATEGORY	DESCRIPTION	PART NO.
	Lamp Extractor * Also available for LA Series	Lamp removing tool	50-005-01
	Blanking Plate Block	PVC stopper to stuff the superfluous hole of the panel board	50-013-01
	Connector * Also available for LA Series	Insulation Socket 2.8 x 0.5 mm	50-014-01
	PCB Mounting Socket		50-015-01
	Mounting Wrench * Also available for LA Series	Use this for tightening the switch in the mounting hole	50-006-01
	Lens Removing Tool	Use this for replacing the fitted color lens	50-007-01
	Spray Cover	Meets requirement of IP65, two pieces of transparent plastic, rectangular head	50-010-01
	Protection Cap	To avoid faulty operation, housing for locking, transparent For square head (90°) For square head (180°) For rectangular head (90°) For rectangular head (180°)	50-011-01 50-011-11 50-011-02 50-011-12