

“Low Side Chopper” IGBT SOT-227 (Trench IGBT), 47 A



SOT-227

**RoHS
COMPLIANT**
FEATURES

- Trench IGBT technology
- Square RBSOA
- HEXFRED® clamping diode
- Positive $V_{CE(on)}$ temperature coefficient
- Fully isolated package
- Speed 8 kHz to 60 kHz
- Very low internal inductance (≤ 5 nH typical)
- Industry standard outline
- UL approved file E78996 
- Material categorization: for definitions of compliance please see www.vishay.com/doc?99912

BENEFITS

- Designed for increased operating efficiency in power conversion: UPS, SMPS, welding, induction heating
- Easy to assemble and parallel
- Direct mounting on heatsink
- Plug-in compatible with other SOT-227 packages
- Low EMI, requires less snubbing

PRIMARY CHARACTERISTICS

| | |
|-------------------------------------|------------------|
| V_{CES} | 1200 V |
| I_C DC | 50 A at 73 °C |
| $V_{CE(on)}$ typical at 50 A, 25 °C | 2.39 V |
| Package | SOT-227 |
| Circuit configuration | Low side chopper |

ABSOLUTE MAXIMUM RATINGS

| PARAMETER | SYMBOL | TEST CONDITIONS | MAX. | UNITS | |
|----------------------------------|------------|--|----------|-------|---|
| Collector to emitter voltage | V_{CES} | | 1200 | V | |
| Continuous collector current | I_C | $T_C = 25\text{ °C}$ | 68 | A | |
| | | $T_C = 80\text{ °C}$ | 47 | | |
| Pulsed collector current | I_{CM} | $T_J = 150\text{ °C}$, $T_p = 6\text{ ms}$, $V_{GE} = 15\text{ V}$ | 150 | | |
| Clamped inductive load current | I_{LM} | | 250 | | |
| Diode continuous forward current | I_F | $T_C = 25\text{ °C}$ | 87 | | |
| | | $T_C = 80\text{ °C}$ | 59 | | |
| Single pulse forward current | I_{FSM} | 10 ms sine or 6 ms rectangular pulse, $T_J = 25\text{ °C}$ | 310 | | |
| Gate to emitter voltage | V_{GE} | | ± 20 | V | |
| Power dissipation, IGBT | P_D | $T_C = 25\text{ °C}$ | 291 | W | |
| | | $T_C = 80\text{ °C}$ | 163 | | |
| Power dissipation, diode | P_D | $T_C = 25\text{ °C}$ | 338 | | |
| | | $T_C = 80\text{ °C}$ | 190 | | |
| RMS isolation voltage | V_{ISOL} | Any terminal to case, $t = 1\text{ min}$ | 2500 | | V |



| ELECTRICAL SPECIFICATIONS ($T_J = 25\text{ }^\circ\text{C}$ unless otherwise specified) | | | | | | |
|---|-------------------------|--|------|------|-----------|----------------------|
| PARAMETER | SYMBOL | TEST CONDITIONS | MIN. | TYP. | MAX. | UNITS |
| Collector to emitter breakdown voltage | $V_{BR(CES)}$ | $V_{GE} = 0\text{ V}, I_C = 2\text{ mA}$ | 1200 | - | - | V |
| Collector to emitter voltage | $V_{CE(on)}$ | $V_{GE} = 15\text{ V}, I_C = 25\text{ A}$ | - | 1.95 | - | |
| | | $V_{GE} = 15\text{ V}, I_C = 50\text{ A}$ | - | 2.39 | 2.8 | |
| | | $V_{GE} = 15\text{ V}, I_C = 25\text{ A}, T_J = 125\text{ }^\circ\text{C}$ | - | 2.13 | - | |
| | | $V_{GE} = 15\text{ V}, I_C = 50\text{ A}, T_J = 125\text{ }^\circ\text{C}$ | - | 2.76 | - | |
| Gate threshold voltage | $V_{GE(th)}$ | $V_{CE} = V_{GE}, I_C = 2\text{ mA}$ | 4.6 | 5.8 | 7.6 | |
| Temperature coefficient of threshold voltage | $V_{GE(th)}/\Delta T_J$ | $V_{CE} = V_{GE}, I_C = 2\text{ mA}$ ($25\text{ }^\circ\text{C}$ to $125\text{ }^\circ\text{C}$) | - | -13 | - | mV/ $^\circ\text{C}$ |
| Collector to emitter leakage current | I_{CES} | $V_{GE} = 0\text{ V}, V_{CE} = 1200\text{ V}$ | - | 1.7 | 50 | μA |
| | | $V_{GE} = 0\text{ V}, V_{CE} = 1200\text{ V}, T_J = 125\text{ }^\circ\text{C}$ | - | 26.2 | - | |
| Diode reverse breakdown voltage | V_{BR} | $I_R = 1\text{ mA}$ | 1200 | - | - | V |
| Diode forward voltage drop | V_{FM} | $I_F = 25\text{ A}, V_{GE} = 0\text{ V}$ | - | 2.11 | 2.42 | V |
| | | $I_F = 50\text{ A}, V_{GE} = 0\text{ V}$ | - | 2.72 | - | |
| | | $I_F = 25\text{ A}, V_{GE} = 0\text{ V}, T_J = 125\text{ }^\circ\text{C}$ | - | 2.04 | - | |
| | | $I_F = 50\text{ A}, V_{GE} = 0\text{ V}, T_J = 125\text{ }^\circ\text{C}$ | - | 2.83 | - | |
| Diode reverse leakage current | I_{RM} | $V_R = 1200\text{ V}$ | - | 4 | 50 | μA |
| | | $T_J = 125\text{ }^\circ\text{C}, V_R = 1200\text{ V}$ | - | 0.8 | - | mA |
| Gate to emitter leakage current | I_{GES} | $V_{GE} = \pm 20\text{ V}$ | - | - | ± 200 | nA |

| SWITCHING CHARACTERISTICS ($T_J = 25\text{ }^\circ\text{C}$ unless otherwise specified) | | | | | | |
|---|--------------|---|--|------|------|-------|
| PARAMETER | SYMBOL | TEST CONDITIONS | MIN. | TYP. | MAX. | UNITS |
| Total gate charge (turn-on) | Q_g | $I_C = 40\text{ A}, V_{CC} = 960\text{ V}, V_{GE} = 15\text{ V}$ | - | 171 | - | nC |
| Gate to emitter charge (turn-on) | Q_{ge} | | - | 22 | - | |
| Gate to collector charge (turn-on) | Q_{gc} | | - | 86 | - | |
| Turn-on switching loss | E_{on} | $I_C = 50\text{ A}, V_{CC} = 600\text{ V}, V_{GE} = 15\text{ V}, R_g = 4.7\text{ }\Omega, L = 500\text{ }\mu\text{H}, T_J = 25\text{ }^\circ\text{C}$ | - | 2.7 | - | mJ |
| Turn-off switching loss | E_{off} | | - | 1.4 | - | |
| Total switching loss | E_{tot} | | - | 4.1 | - | |
| Turn-on switching loss | E_{on} | | - | 4.1 | - | |
| Turn-off switching loss | E_{off} | | - | 2.3 | - | |
| Total switching loss | E_{tot} | | - | 6.4 | - | |
| Turn-on delay time | $t_{d(on)}$ | | $I_C = 50\text{ A}, V_{CC} = 600\text{ V}, V_{GE} = 15\text{ V}, R_g = 4.7\text{ }\Omega, L = 500\text{ }\mu\text{H}, T_J = 125\text{ }^\circ\text{C}$ | - | 8 | |
| Rise time | t_r | - | | 11 | - | |
| Turn-off delay time | $t_{d(off)}$ | - | | 81 | - | |
| Fall time | t_f | - | | 179 | - | |
| Reverse bias safe operating area | RBSOA | $T_J = 150\text{ }^\circ\text{C}, I_C = 250\text{ A}, R_g = 4.7\text{ }\Omega, V_{GE} = 15\text{ V to } 0\text{ V}, V_{CC} = 700\text{ V}, V_P = 1200\text{ V}$ | Fullsquare | | | |
| Diode reverse recovery time | t_{rr} | $I_F = 50\text{ A}, di_F/dt = 200\text{ A}/\mu\text{s}, V_R = 200\text{ V}$ | - | 129 | - | ns |
| Diode peak reverse current | I_{rr} | | - | 11 | - | A |
| Diode recovery charge | Q_{rr} | | - | 710 | - | nC |
| Diode reverse recovery time | t_{rr} | $I_F = 50\text{ A}, di_F/dt = 200\text{ A}/\mu\text{s}, V_R = 200\text{ V}, T_J = 125\text{ }^\circ\text{C}$ | - | 208 | - | ns |
| Diode peak reverse current | I_{rr} | | - | 17 | - | A |
| Diode recovery charge | Q_{rr} | | - | 1768 | - | nC |



| THERMAL AND MECHANICAL SPECIFICATIONS | | | | | | |
|--|----------------|-----------------------|------|------|------------|-------------|
| PARAMETER | SYMBOL | TEST CONDITIONS | MIN. | TYP. | MAX. | UNITS |
| Junction and storage temperature range | T_J, T_{Stg} | | -40 | - | 150 | °C |
| Junction to case | IGBT | | - | - | 0.43 | °C/W |
| | Diode | | - | - | 0.37 | |
| Case to heatsink | R_{thCS} | Flat, greased surface | - | 0.05 | - | |
| Weight | | | - | 30 | - | g |
| Mounting torque | | Torque to terminal | - | - | 1.1 (9.7) | Nm (lbf.in) |
| | | Torque to heatsink | - | - | 1.8 (15.9) | Nm (lbf.in) |
| Case style | | SOT-227 | | | | |

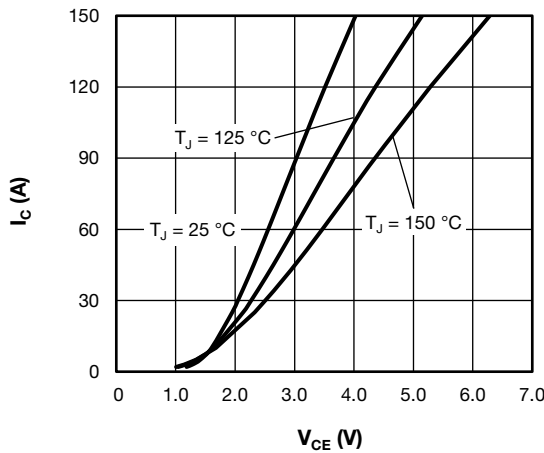

Fig. 1 - Typical Trench IGBT Output Characteristics, $V_{GE} = 15\text{ V}$

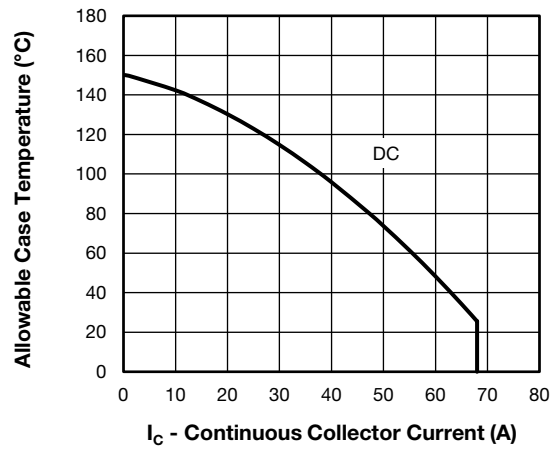

Fig. 3 - Maximum Trench IGBT Continuous Collector Current vs. Case Temperature

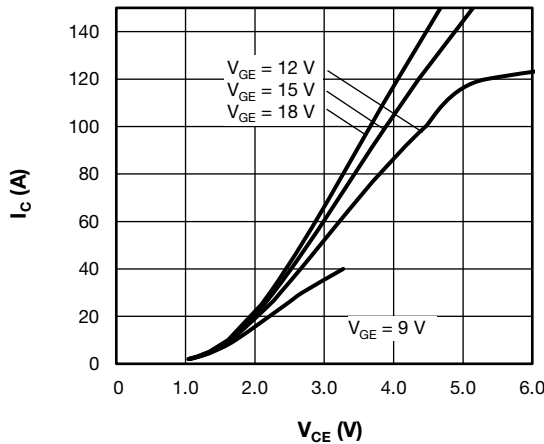

Fig. 2 - Typical Trench IGBT Output Characteristics, $T_J = 125\text{ °C}$

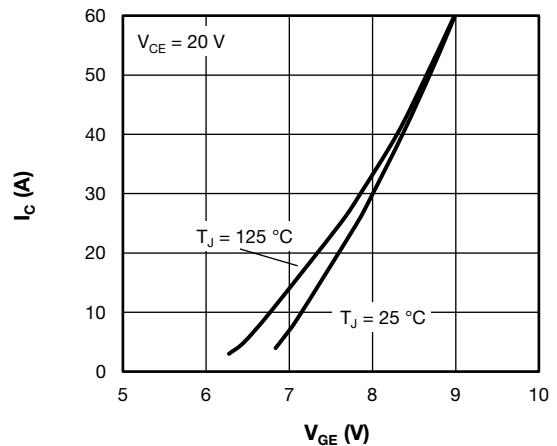

Fig. 4 - Typical Trench IGBT Transfer Characteristic

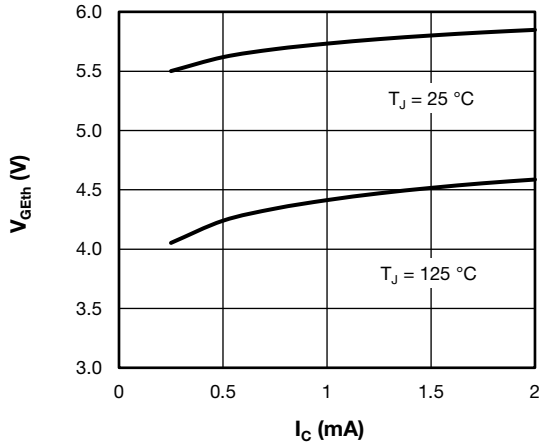

Fig. 5 - Typical Trench IGBT Gate Threshold Voltage

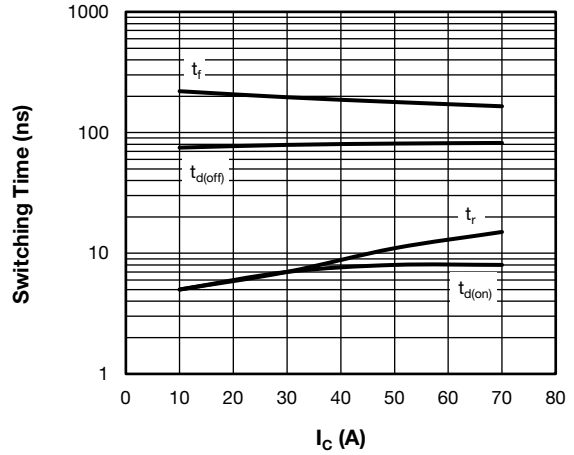

Fig. 8 - Typical Trench IGBT Switching Time vs. I_C
 $T_J = 125\text{ °C}$, $V_{CC} = 600\text{ V}$, $R_g = 4.7\text{ }\Omega$, $V_{GE} = +15\text{ V}/-15\text{ V}$, $L = 500\text{ }\mu\text{H}$

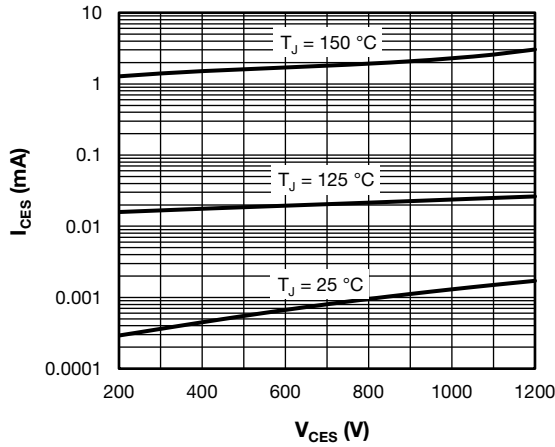

Fig. 6 - Typical Trench IGBT Zero Gate Voltage Collector Current

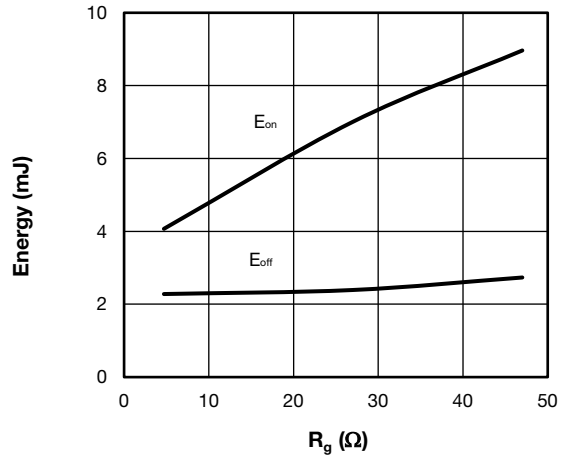

Fig. 9 - Typical Trench IGBT Energy Losses vs. R_g
 $T_J = 125\text{ °C}$, $V_{CC} = 600\text{ V}$, $I_C = 50\text{ A}$, $V_{GE} = +15\text{ V}/-15\text{ V}$, $L = 500\text{ }\mu\text{H}$

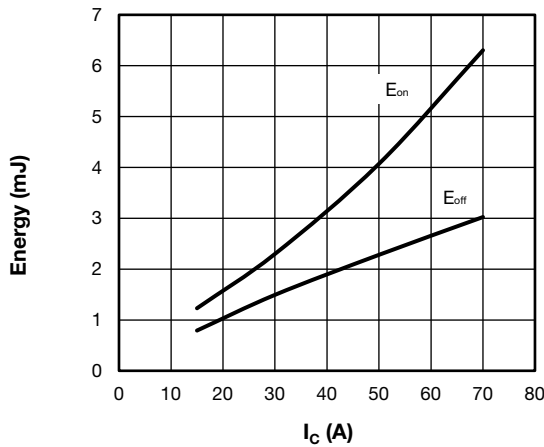

Fig. 7 - Typical Trench IGBT Energy Loss vs. I_C
 $T_J = 125\text{ °C}$, $V_{CC} = 600\text{ V}$, $R_g = 4.7\text{ }\Omega$, $V_{GE} = +15\text{ V}/-15\text{ V}$, $L = 500\text{ }\mu\text{H}$

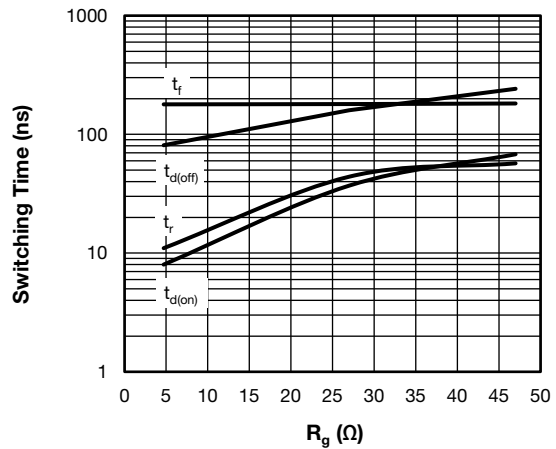

Fig. 10 - Typical Trench IGBT Switching Time vs. R_g
 $T_J = 125\text{ °C}$, $V_{CC} = 600\text{ V}$, $I_C = 50\text{ A}$, $V_{GE} = +15\text{ V}/-15\text{ V}$, $L = 500\text{ }\mu\text{H}$

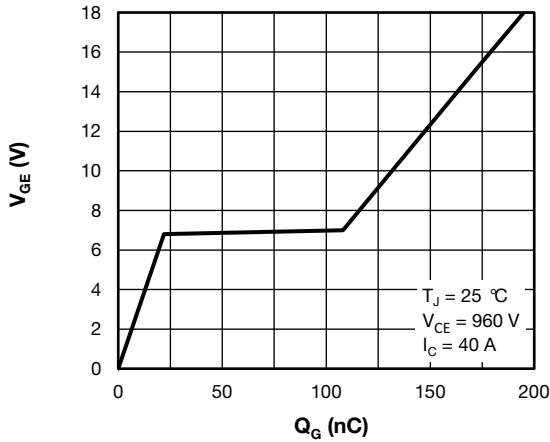

Fig. 11 - Typical Trench IGBT Gate Charge vs. Gate to Emitter Voltage

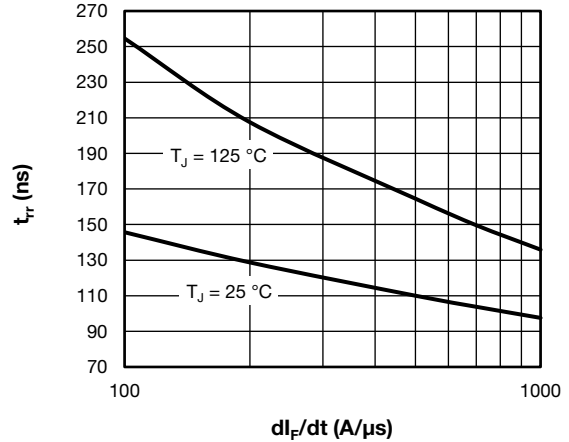

Fig. 14 - Typical Diode Reverse Recovery Time vs. dI_F/dt

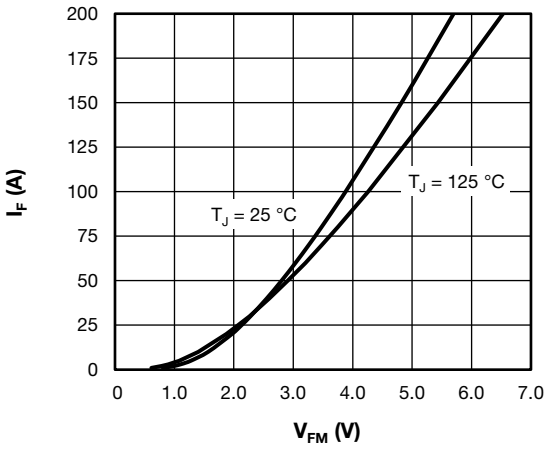

Fig. 12 - Typical Diode Forward Characteristic

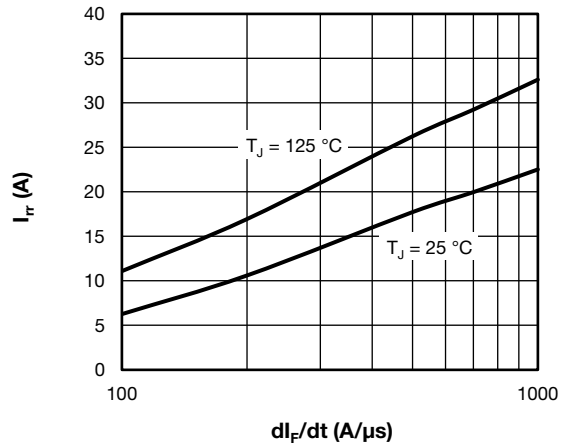

Fig. 15 - Typical Diode Reverse Recovery Current vs. dI_F/dt

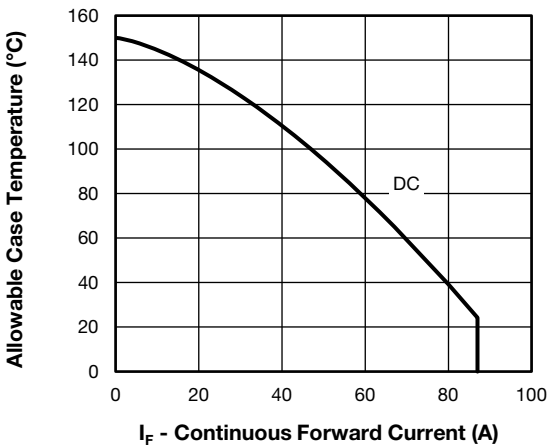

Fig. 13 - Maximum Diode Continuous Forward Current vs. Case Temperature

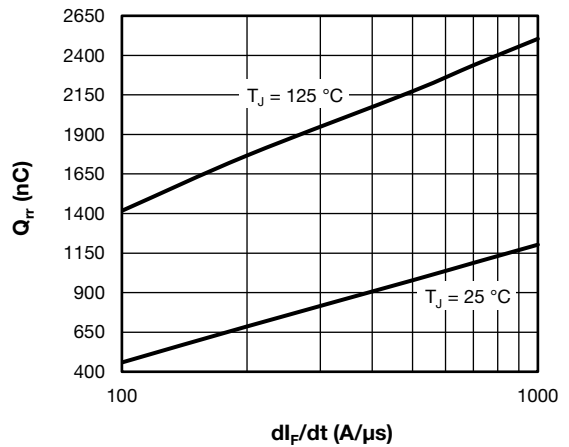

Fig. 16 - Typical Diode Reverse Recovery Charge vs. dI_F/dt

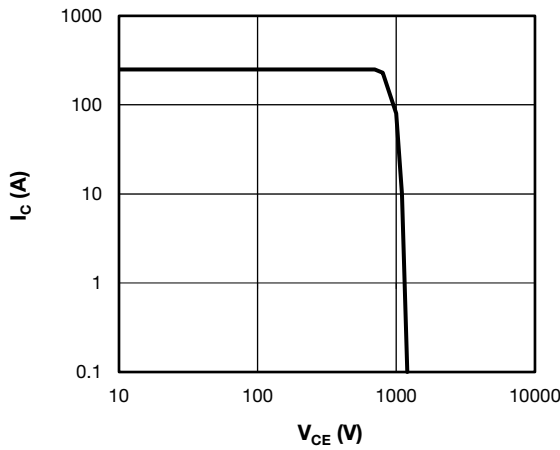

Fig. 17 - Trench IGBT Reverse BIAS SOA
 $T_J = 150\text{ }^\circ\text{C}$, $I_C = 250\text{ A}$, $R_g = 4.7\ \Omega$, $V_{GE} = +15\text{ V/0 V}$,
 $V_{CC} = 700\text{ V}$, $V_p = 1200\text{ V}$

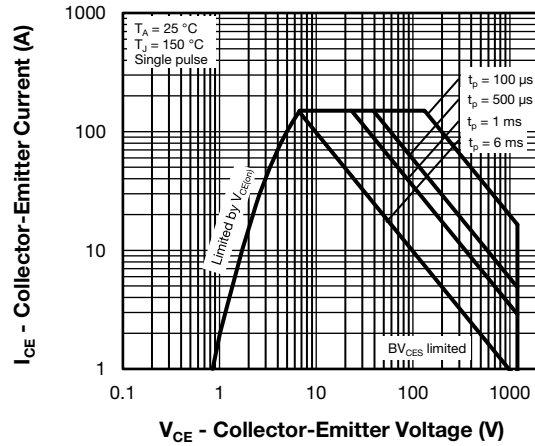

Fig. 18 - Trench IGBT Safe Operating Area

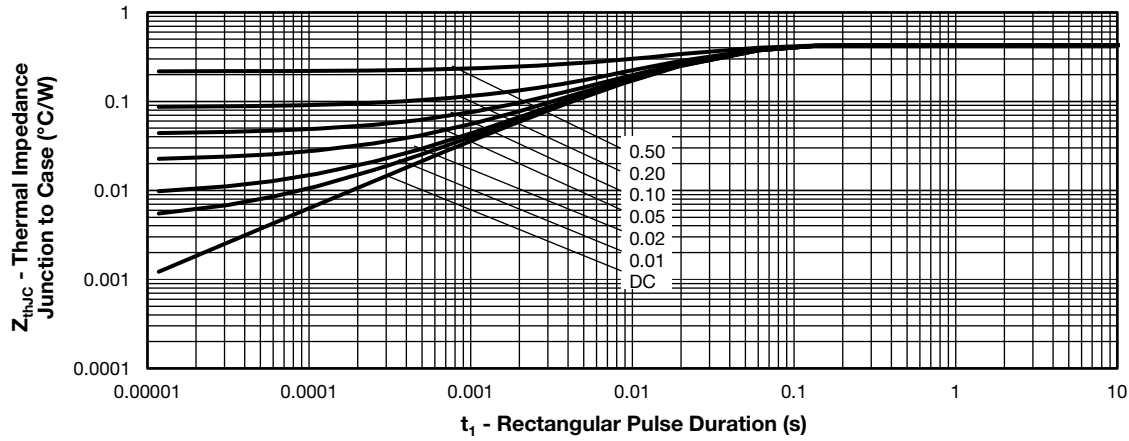

Fig. 19 - Maximum Trench IGBT Thermal Impedance Z_{thJC} Characteristics

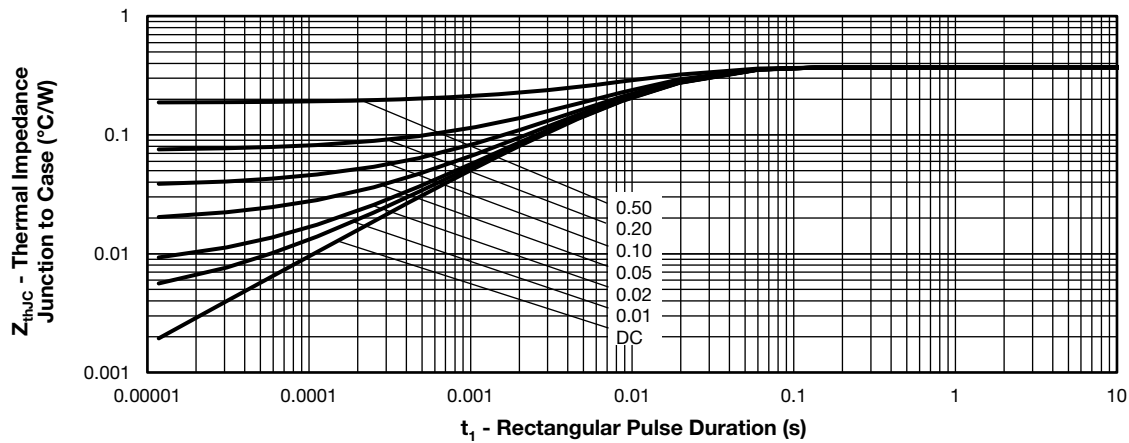
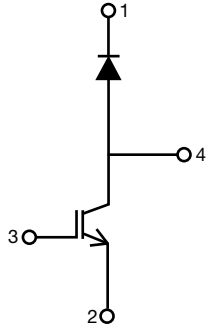
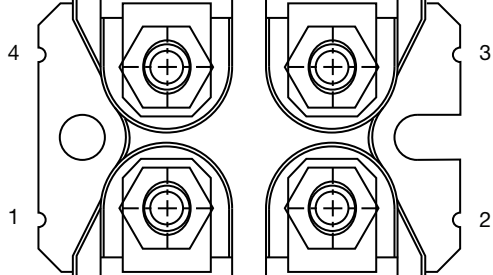

Fig. 20 - Maximum Diode Thermal Impedance Z_{thJC} Characteristics

ORDERING INFORMATION TABLE

| | | | | | | | | | |
|-------------|------------|----------|----------|-----------|----------|----------|------------|----------|----------|
| Device code | VS- | G | T | 55 | L | A | 120 | U | X |
| | ① | ② | ③ | ④ | ⑤ | ⑥ | ⑦ | ⑧ | ⑨ |

- 1** - Vishay Semiconductors product
- 2** - Insulated gate bipolar transistor (IGBT)
- 3** - T = trench IGBT
- 4** - Current rating (55 = 55 A)
- 5** - Circuit configuration (L = low side chopper)
- 6** - Package indicator (A = SOT-227)
- 7** - Voltage rating (120 = 1200 V)
- 8** - Speed/type (U = ultrafast IGBT)
- 9** - Diode (X = HEXFRED[®] diode)

| CIRCUIT CONFIGURATION | | | |
|-----------------------|----------------------------|---|---|
| CIRCUIT | CIRCUIT CONFIGURATION CODE | CIRCUIT DRAWING | |
| Low side chopper | L |  | Lead Assignment  |

| LINKS TO RELATED DOCUMENTS | |
|----------------------------|--|
| Dimensions | www.vishay.com/doc?95423 |
| Packaging information | www.vishay.com/doc?95425 |



SOT-227 Generation 2

DIMENSIONS in millimeters (inches)

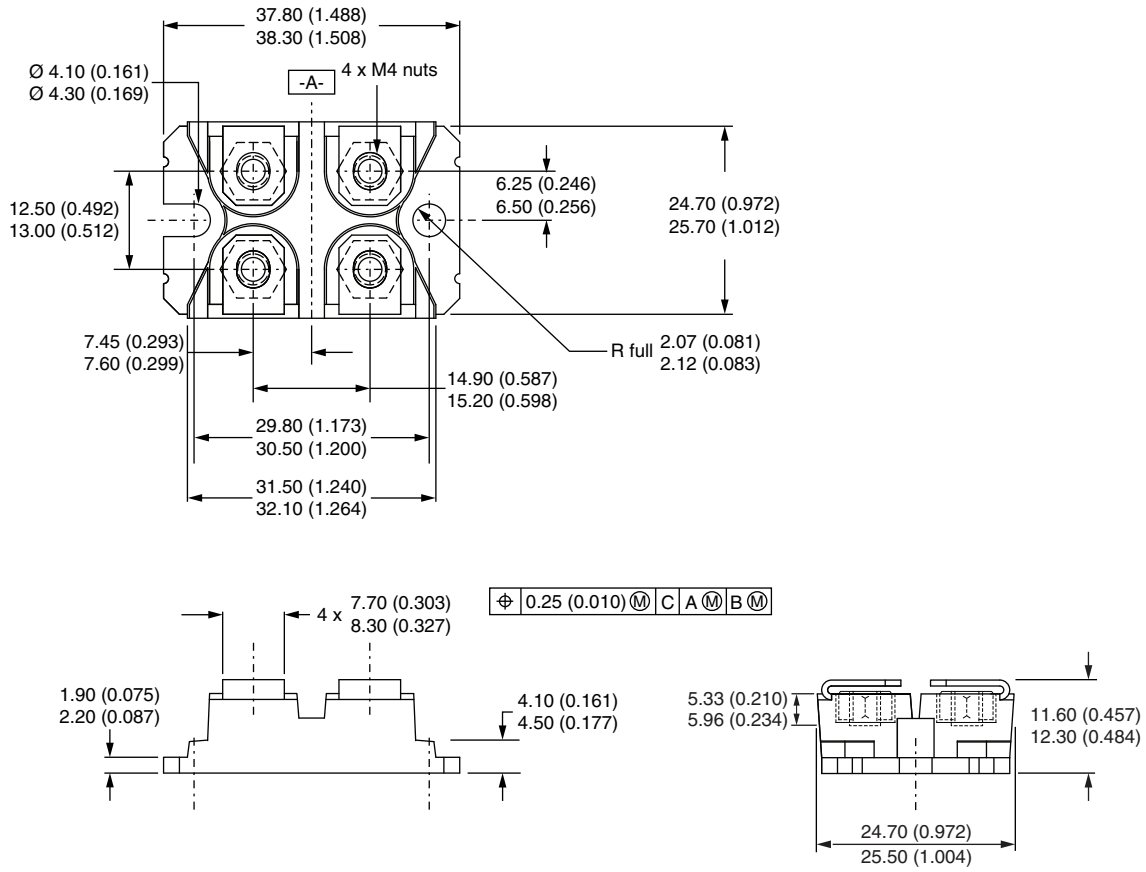

Note

- Controlling dimension: millimeter



Disclaimer

ALL PRODUCT, PRODUCT SPECIFICATIONS AND DATA ARE SUBJECT TO CHANGE WITHOUT NOTICE TO IMPROVE RELIABILITY, FUNCTION OR DESIGN OR OTHERWISE.

Vishay Intertechnology, Inc., its affiliates, agents, and employees, and all persons acting on its or their behalf (collectively, "Vishay"), disclaim any and all liability for any errors, inaccuracies or incompleteness contained in any datasheet or in any other disclosure relating to any product.

Vishay makes no warranty, representation or guarantee regarding the suitability of the products for any particular purpose or the continuing production of any product. To the maximum extent permitted by applicable law, Vishay disclaims (i) any and all liability arising out of the application or use of any product, (ii) any and all liability, including without limitation special, consequential or incidental damages, and (iii) any and all implied warranties, including warranties of fitness for particular purpose, non-infringement and merchantability.

Statements regarding the suitability of products for certain types of applications are based on Vishay's knowledge of typical requirements that are often placed on Vishay products in generic applications. Such statements are not binding statements about the suitability of products for a particular application. It is the customer's responsibility to validate that a particular product with the properties described in the product specification is suitable for use in a particular application. Parameters provided in datasheets and / or specifications may vary in different applications and performance may vary over time. All operating parameters, including typical parameters, must be validated for each customer application by the customer's technical experts. Product specifications do not expand or otherwise modify Vishay's terms and conditions of purchase, including but not limited to the warranty expressed therein.

Hyperlinks included in this datasheet may direct users to third-party websites. These links are provided as a convenience and for informational purposes only. Inclusion of these hyperlinks does not constitute an endorsement or an approval by Vishay of any of the products, services or opinions of the corporation, organization or individual associated with the third-party website. Vishay disclaims any and all liability and bears no responsibility for the accuracy, legality or content of the third-party website or for that of subsequent links.

Except as expressly indicated in writing, Vishay products are not designed for use in medical, life-saving, or life-sustaining applications or for any other application in which the failure of the Vishay product could result in personal injury or death. Customers using or selling Vishay products not expressly indicated for use in such applications do so at their own risk. Please contact authorized Vishay personnel to obtain written terms and conditions regarding products designed for such applications.

No license, express or implied, by estoppel or otherwise, to any intellectual property rights is granted by this document or by any conduct of Vishay. Product names and markings noted herein may be trademarks of their respective owners.