

# Anaren®

What'll we think of next?®

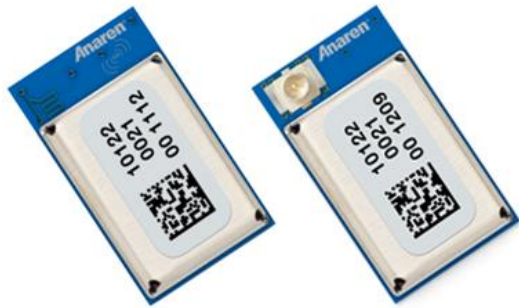

## Anaren Integrated Radio

### A2541R24x User's Manual

Release Date: 11/14/16



Anaren Integrated Radio

**THIS PAGE INTENTIONALLY LEFT BLANK**

# USER'S MANUAL

## Models A2541R24A and A2541R24C

### Contents

1.	Overview .....	5
1.1.	A2541R24A.....	5
1.2.	A2541R24C.....	5
1.3.	Features.....	6
1.4.	Theory of Operation.....	7
1.5.	Applications.....	10
2.	Approvals and Usage .....	11
2.1.	Product Approvals.....	11
2.1.1.	USA (Federal Communications Commission, FCC).....	11
2.1.1.1.	FCC Labeling Requirements .....	11
2.1.1.2.	End User Manual .....	12
2.1.1.3.	RF Exposure.....	12
2.1.2.	Canada (Industry Canada, IC).....	12
2.1.2.1.	IC Labeling Requirements .....	14
2.1.2.2.	RF Exposure.....	16
2.1.3.	Europe (Conformité Européenne, CE).....	16
2.1.4.	Taiwan (NCC,  ).....	17
2.1.4.1.	NCC warning statement: .....	17
2.1.4.2.	NCC ID warning statement:.....	17
2.1.5.	Bluetooth Special Interest Group (SIG) .....	18
2.2.	Potential Interference Sources .....	18
2.2.1.	WLAN.....	18
2.2.2.	Classic Bluetooth .....	18
2.2.3.	Microwave ovens.....	19
2.2.4.	Other Interference .....	19
2.2.5.	Time critical data.....	19
2.3.	Approved Usage .....	20
2.3.1.	USA and Canada.....	20
2.3.2.	Europe .....	21
2.3.3.	Bluetooth .....	21
3.	Electrical Characteristics .....	22
3.1.	Absolute Maximum Ratings .....	22
3.2.	Operating Conditions .....	23
3.3.	Pin Out.....	23
3.3.1.	A2541R24x10 (Module with TI BLE Stack).....	23
3.3.2.	Pinout.....	25
3.4.	Recommended Layout (dimensions in mm) .....	27
3.5.	Power Supply Considerations.....	29
4.	Mechanical and Process.....	30
4.1.	Radio Module Details (dimensions in mm).....	30
4.1.1.	A2541R24A .....	30
4.1.2.	A2541R24C.....	30
4.2.	Packaging Details (dimensions in mm).....	31



4.2.1.	<i>Matrix Tray Packaging</i> .....	31
4.2.2.	<i>Tape-Reel Packaging</i> .....	31
4.3.	<b>Soldering</b> .....	32
4.3.1.	<i>Manual Mounting Procedure</i> .....	32
4.3.2.	<i>Automated Mounting Procedure</i> .....	33

# 1. Overview

The A2541R24A and A2541R24C are surface mount 2.4GHz RF transceivers incorporating *Bluetooth*<sup>®</sup> SMART technology per the Bluetooth v4.0 core specification. The A2541R24A has an integral antenna, whereas the A2541R24C utilizes an external antenna through a U.FL connector (see Table 1). These modules incorporate crystals, a step down converter, the required RF matching and filtering for regulatory compliance as well as filtering for noise reduction and sensitivity. They operate in the global unlicensed 2.4GHz ISM/SRD frequency band. The modules are ideal for achieving low power, long range wireless connectivity without having to deal with extensive protocol, RF, antenna design and regulatory compliance, and provide quick time to market. They are 100% tested to provide consistent performance.

The A2541R24A and A2541R24C modules have received regulatory approvals for modular devices in the United States (FCC), Canada (IC) and Europe (ETSI). The modular approval allows the end user to place either an A2541R24A or an A2541R24C with an approved antenna inside a finished product without having to perform costly regulatory testing for an intentional RF radiator. Section 2.3 has information on the requirements for the end user/integrator to fulfill in order to use the modules without intentional radiator regulatory testing.

The A2541R24A and A2541R24C are based on the CC2541 SoC transceiver from Texas Instruments (TI). The CC2541 combines the excellent performance of a leading RF transceiver with an industry-standard enhanced 8051 microcontroller unit (MCU), 256-KB in-system programmable flash memory, 8-KB RAM with retention in all power modes, and many other powerful features. The CC2541 has various operating modes, making it highly suited for systems where ultralow power consumption is required. Short transition times between operating modes further ensure low energy consumption. All control lines are provided at module level for full control of the operation. Please see the user’s guide for CC2541 ([www.ti.com](http://www.ti.com)) for how to operate, program and control these modules.

The A2541R24A and A2541R24C modules measure 11 mm x 19 mm x 2.5 mm. The modules are footprint compatible with each other.

## 1.1. A2541R24A

The A2541R24A has an integral antenna, providing high efficiency and near omni-directional radiation pattern. This approach offers the lowest system cost when the application allows collocation of radio and antenna. See Figure 9 - Figure 10 for more information on antenna location and enclosure considerations.

## 1.2. A2541R24C

The A2541R24C has a compact antenna connector that allows for locating the antenna away from the module due to form/function or in order to exit a metal enclosure. Please see Table 1 for a list of approved antennas.



### 1.3. Features

#### Features:

- 2.4 GHz incorporating Bluetooth Smart technology and Proprietary RF System-on-Chip
- 2.0 to 3.6 V operation
- High-Performance and low-power 8051 microcontroller core
- 256 kB Programmable Flash
- 8 kB RAM with retention in all power modes
- Programmable output power up to +1 dBm
- 18 General Purpose I/O Pins
- Features TI's TPS62730 step-down converter
- Low current consumption (14mA in RX and, 13mA @0dBm TX with step down converter ON)
- Excellent receiver sensitivity, -90 dBm average in BLE HGM with <1% PER.
- 3 Low power/sleep modes from 0.5µA to 270µA.
- General-Purpose Timers (One 16-Bit, Two 8-Bit), 32-kHz Sleep Timer with Capture
- RSSI support
- Battery Monitor and Temperature Sensor
- 12-Bit ADC with eight channels and configurable resolution
- AES Security Coprocessor
- 2 USARTs with several serial protocol support
- Watchdog Timer
- RoHS Compliant
- Shielded package
- LGA Footprint
- Very Small package size:  
11mm x 19mm x 2.5mm
- Approximate weight 0.7 grams

#### Benefits Summary:

- Operating temperature-40 °C to +85 °C
- 100% RF Tested in production for repeatable performance
- No RF engineering experience necessary
- No protocol experience necessary
- Only requires a 2 layer Host PCB implementation
- FCC 15.247, IC RSS-210 and IC RSS-Gen certified.
- Compliant with ETSI EN 300 328
- No regulatory "Intentional radiator" testing required for integrating module into end product. Simple certification labeling replaces testing.



## 1.4. Theory of Operation

The A2541R24A and A2541R24C modules operate in the global 2.4 GHz ISM/SRD frequency band. They can be used to implement a variety of networks, including point to point, point to multi-point, peer to peer and mesh networks.

Figure 1 and Figure 2 show the functionality of A2541R24A and A2541R24C, respectively. Both modules operate in a similar manner except the antenna part where A2541R24A communicates through a built-in antenna, and A2541R24C communicates through an external antenna attached to a U.F.L antenna port.

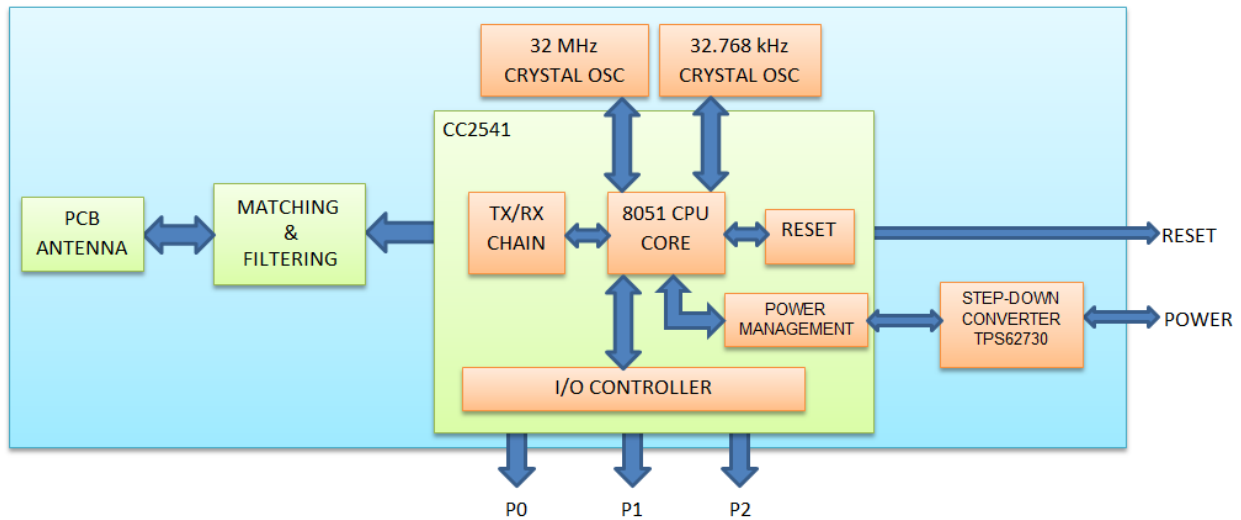

Figure 1 The functionality of the A2541R24A, using an internal antenna

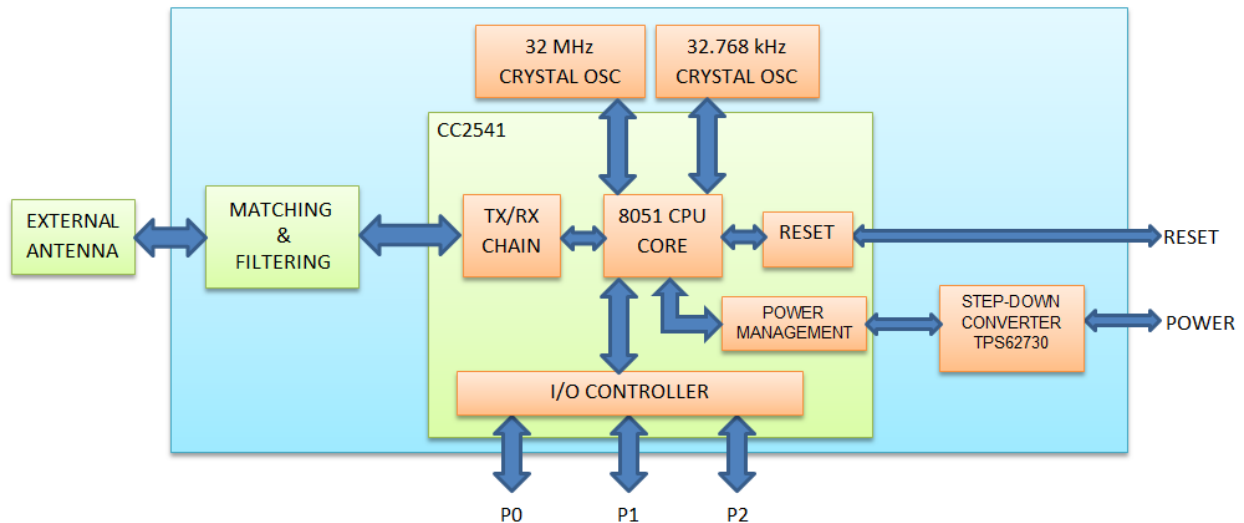
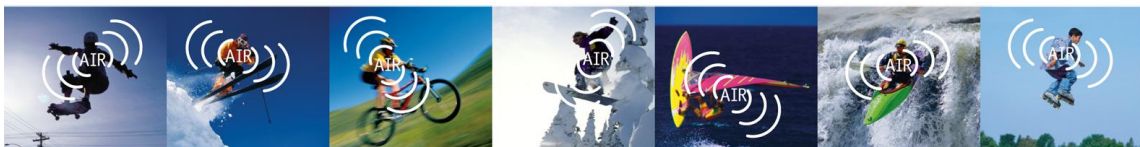

Figure 2 The functionality of the A2541R24C, using an external antenna



The description of the functional blocks shown in Figure 1 and Figure 2 is given as follows:

- Antenna
  - The antenna couples energy between the air and the module. The integral antenna and the external monopole antenna, both centered at 2441.75 MHz, provide a near omni-directional antenna pattern with high efficiency such that the application will work in any direction. Note that the end radiation pattern depends not only on the antenna, but also the ground plane, enclosure and installation environment.
- Matching & Filtering
  - The matching provides the correct loading of the transmit amplifier to achieve the highest output power as well as the correct loading for the receive LNA to achieve the best sensitivity.
  - Filtering removes spurious signals to comply with regulatory intentional radiator requirements, provides reduced susceptibility to power supply and digital noise, and filters out RF and high frequency noise from the communication data and control link.
- TX/RX Chain
  - TX/RX chain handles transmitting and receiving of the communication data based on the radio register settings. It involves the coordination of several blocks including modulator, demodulator, AGC control, frequency synthesizer and frame control.
- Crystal
  - Crystal oscillator provides the necessary clock reference for the whole module operation. The A2541R24A and A2541R24C modules use two crystals: a 32 MHz crystal and a 32.768 kHz crystal.
- Power Management
  - Power management ensures a stable supply for the internal functions, as well as providing means for a low power sleep mode.
- CPU and Memory
  - The 8051 CPU core used in the CC2541 device is a single-cycle 8051-compatible core. It has three different memory-access buses (SFR, DAT and CODE/XDATA) with single-cycle access to SFR, DATA, and the main SRAM. It also includes a debug interface and an 18-input extended interrupt unit.
  - The memory arbiter connects the CPU and DMA controller with the physical memories and all peripherals through the SFR bus.
  - The 8-KB SRAM maps to the DATA memory space and to parts of the XDATA memory spaces. This is an ultralow-power SRAM that retains its contents even when the digital part is powered off.
  - 256 KB flash block provides in-circuit programmable non-volatile program memory for the device, and maps into the CODE and XDATA memory spaces. In addition to holding the program code, it also allows the application to save data that must be preserved such that it is available after restarting the device.
- I/O Controller
  - The I/O controller is responsible for all general-purpose I/O pins. The CPU can configure whether peripheral modules control certain pins or they are under software control, and if so, whether they are configured as input or output.





- Step-Down Converter (TPS62730)
  - The step-down converter (TPS62730, DC-DC Converter) provides a fixed 2.1V input voltage to the transceiver chip internally when it is in DC-DC mode and the module input voltage is above 2.3V.
  - BYPASS mode with a typical 30nA current consumption supports the module’s sleep and low power modes.
  - The step-down converter can be controlled via firmware or by an external signal on module pin 16. When controlled by firmware the converter is placed into Bypass mode whenever the CC2541 is in a low-power state, otherwise the converter is ON (i.e. switching). This helps reduce overall power consumption for systems operating above 2.1V since the CC2541 device is powered by the output of the TPS62730 instead of the radio module’s supply pin. That equates to about 30% reduction in current draw while the radio is in a higher power active state when operating at 3.0V and about 40% reduction in current when operating at 3.6V (current reduction is at module input).
  - When the converter is in DC-DC mode the radio module’s I/O signals will be at 2.1V logic levels, whereas in Bypass mode the I/O will be at logic levels equal to the module’s supply voltage. This is an important consideration when deciding whether to force the DC-DC converter into Bypass mode or allow firmware to cycle between ON and Bypass. In the latter scenario, all devices that interface to the A2541 must be compatible with the changing logic levels.
  - Connections to the step-down converter pins are identified in Figure 3 below. For brevity, filtering components are not shown.

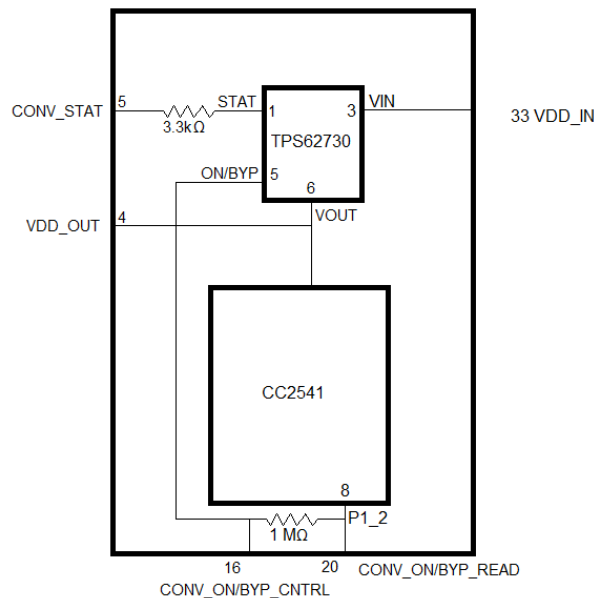

Figure 3 Internal connections for TPS62730 Step-Down Converter



Table 1 Approved Antennas

Item	Part Number	Manufacturer	Type	Gain (dBi)
1	Integral part of A2541R24A	Anaren	Integral Antenna	2
2	66089-2406	Anaren	Monopole whip, 6 mm lead	3
3	66089-2430	Anaren	Monopole whip, 30 mm lead	3

## 1.5. Applications

- Bluetooth SMART Systems
- Industrial Control and Monitoring
- Home/Building Automation
- Lighting Systems
- Low-Power Wireless Sensor Networks
- Sports monitoring, health & wellness



Anaren Integrated Radio

## 2. Approvals and Usage

The A2541R24A and A2541R24C have been designed to meet many national regulations for worldwide ISM band use. In particular, the radio modules have been certified to the following standards.

### 2.1. Product Approvals

#### 2.1.1. USA (Federal Communications Commission, FCC)

The A2541R24A and A2541R24C modules have been tested to comply with FCC CFR47 Part 15 sub-part C “Intentional Radiators” standard. The modules meet the requirements for modular transmitter approval as detailed in FCC public notice DA 00-1407 released in June 26, 2000. The modular transmitter approval eliminates the need to re-perform costly ‘intentional radiator’ testing when submitting an end product for certification.

(15.19a3) The module complies with part 15 of the FCC rules. Operation is subject to the following two conditions: (1) this device may not cause harmful interference, and (2) this device must accept any interference received, including interference that may cause undesired operation.

Any changes or modifications not expressly approved by the party responsible for compliance could void the user’s authority to operate the equipment.

##### 2.1.1.1. FCC Labeling Requirements

The A2541R24A and A2541R24C modules have been labeled with their own FCC ID number and if the FCC ID is not visible when the module is installed inside another device, then the outside of the finished product into which the module is installed must also display a label referring to the enclosed module. This exterior label can use wording such as the following:

Contains Transmitter Module FCC ID: X7J-A12062101

-or-

Contains FCC ID: X7J-A12062101

This device complies with Part 15 of the FCC Rules.

Operation is subject to the following two conditions:

(1) this device may not cause harmful interference, and (2) this device must accept any interference received, including interference that may cause undesired operation.

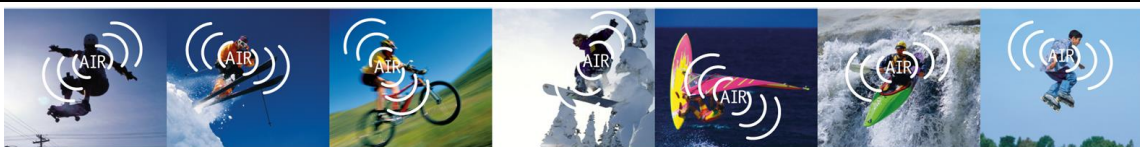

### 2.1.1.2. End User Manual

The end user manual should include the following statement:

This equipment has been tested and found to comply with the limits for a Class B digital device, pursuant to part 15 of the FCC Rules. These limits are designed to provide reasonable protection against harmful interference in a residential installation. This equipment generates, uses and can radiate radio frequency energy and, if not installed and used in accordance with the instructions, may cause harmful interference to radio communications. However, there is no guarantee that interference will not occur in a particular installation. If this equipment does cause harmful interference to radio or television reception, which can be determined by turning the equipment off and on, the user is encouraged to try to correct the interference by one or more of the following measures:

- Reorient or relocate the receiving antenna.
- Increase the separation between the equipment and receiver.
- Connect the equipment into an outlet on a circuit different from that to which the receiver is connected.
- Consult the dealer or an experienced radio/TV technician for help.

### 2.1.1.3. RF Exposure

All transmitters regulated by FCC must comply with RF exposure requirements. OET Bulletin 65 "Evaluating Compliance with FCC Guidelines for Human Exposure to Radio Frequency Electromagnetic Fields" provides assistance in determining whether proposed or existing transmitting facilities, operations or devices comply with limits for human exposure to Radio Frequency (RF) fields adopted by the Federal Communications Commission (FCC). The bulletin offers guidelines and suggestions for evaluating compliance.

If appropriate, compliance with exposure guidelines for mobile and unlicensed devices can be accomplished by the use of warning labels and by providing users with information concerning minimum separation distances from transmitting structures and proper installation of antennas.

The following statement must be included as a CAUTION statement in manuals and OEM products to alert users of FCC RF Exposure compliance:

To satisfy FCC requirements the antenna used with this transmitter must not be co-located or operating in conjunction with any other antenna or transmitter except as permitted by FCC multi-transmitter procedures.

### 2.1.2. Canada (Industry Canada, IC)

The A2541R24A and A2541R24C modules have been certified for use in Canada under Industry Canada (IC) Radio Standards Specification (RSS) RSS-210 and RSS-Gen.



Anaren Integrated Radio

From section 3.2 RSS-Gen, Issue 3, December 2010, Modular Approval for Category I Equipment or Category II Equipment:

*“Modular approval permits the installation of the same module in a host device or multiple host devices without the need to recertify the device. Equipment certification for a modular device may be sought for either Category I equipment or Category II equipment.*

*Transmitters designed as modules for the installation in a host device may obtain equipment certification as a modular device provided that the applicable RSS is met and the following conditions in this section are met.”*

In section 7.1.2 Transmitter Antenna, it has been mentioned that the user manuals for transmitters shall display the following notice in a conspicuous location:

**Notice:** *Under Industry Canada regulations, this radio transmitter may only operate using an antenna of a type and maximum (or lesser) gain approved for the transmitter by Industry Canada. To reduce potential radio interference to other users, the antenna type and its gain should be so chosen that the equivalent isotropically radiated power (e.i.r.p.) is not more than that necessary for successful communication.*

**Avis:** *Sous la réglementation d'Industrie Canada, ce transmetteur radio ne peut fonctionner qu'en utilisant seulement une antenne d'un type et d'un maximum (ou moins) de gain approuvé pour l'émetteur par Industrie Canada. Pour réduire des potentielles interférences radio pour les autres utilisateurs, le type d'antenne et son gain doivent être choisis de sorte que la puissance isotrope rayonnée équivalente (PIRE) ne dépasse pas ce qui est nécessaire pour une communication réussie.*



In section 7.1.2 Transmitter Antenna, it has been mentioned that the user manuals for transmitters equipped with detachable antennas shall also contain the following notice in a conspicuous location:

**Notice:** *This radio transmitter (IC: 8975A-A12062101) has been approved by Industry Canada to operate with the antenna types listed below with the maximum permissible gain and required antenna impedance for each antenna type indicated. Antenna types not included in this list, having a gain greater than the maximum gain indicated for that type, are strictly prohibited for use with this device.*

**Avis:** *Cet émetteur radio (IC: 8975A-A12062101) a été approuvé par Industrie Canada pour fonctionner avec les types d'antennes énumérés ci-dessous avec le gain maximal admissible et l'impédance d'antenne requise pour chaque type d'antenne indiqué. Les types d'antennes ne figurant pas dans cette liste, ayant un gain supérieur au gain maximal indiqué pour ce type, sont strictement interdits pour l'utilisation avec cet appareil.*

Item numéro d'article	Part Number Référence	Manufacturer Fabricant	Type catégorie	Gain (dBi) Gain
1	Integral part of A2541R24A Partie intégrante de A2541R24A	Anaren	Integral Antenna antenne intégrée	2
2	66089-2406	Anaren	Monopole whip, 6 mm lead Antenne monopôle, longueur 6 mm	3
3	66089-2430	Anaren	Monopole whip, 30 mm lead Antenne monopôle, longueur 30 mm	3

### 2.1.2.1. IC Labeling Requirements

From section 3.2.1 RSS-Gen, Issue 3, December 2010, Labeling Requirements for the Host Device:

The host device shall be properly labeled to identify the modules within the host device. The Industry Canada certification label of a module shall be clearly visible at all times when installed in the host device, otherwise the host device must be labeled to display the Industry Canada certification number of the module, preceded by the words "Contains transmitter module", or the word "Contains", or similar wording expressing the same meaning.

From section 5.2, RSS-Gen, Issue 3, December 2010, Equipment Certification Numbers and Labels:

*Every unit of Category I radio apparatus certified for marketing and use in Canada shall bear a permanent label on which is indelibly displayed the model number and Industry Canada certification number of the equipment model (transmitter, receiver, or inseparable combination*



Anaren Integrated Radio

thereof). Each model shall be identified by a unique combination of a model number and a certification number, which are assigned as described below in this section.

The label shall be securely affixed to a permanently attached part of the device, in a location where it is visible or easily accessible to the user, and shall not be readily detachable. The label shall be sufficiently durable to remain fully legible and intact on the device in all normal conditions of use throughout the device’s expected lifetime. These requirements may be met either by a separate label or nameplate permanently attached to the device or by permanently imprinting or impressing the label directly onto the device.

The label text shall be legible without the aid of magnification, but is not required to be larger than 8-point font size. If the device is too small to meet this condition, the label information may be included in the user manual upon agreement with Industry Canada.

Section 5.2 continues:

The model number is assigned by the applicant and shall be unique to each model of radio apparatus under that applicant’s responsibility. The model number shall be displayed on the label preceded by the text: “Model:”, so it appears as follows:

*Model: model number assigned by applicant*

Label:

Contains/Contient IC: 8975A- A12062101

**Notice:** This device complies with Industry Canada licence-exempt RSS standard(s). Operation is subject to the following two conditions: (1) this device may not cause interference, and (2) this device must accept any interference, including interference that may cause undesired operation of the device.

**Avis:** Cet appareil est conforme avec Industrie Canada RSS standard exempts de licence (s). Son fonctionnement est soumis aux deux conditions suivantes: (1) cet appareil ne peut pas provoquer d’interférences et (2) cet appareil doit accepter toute interférence, y compris les interférences qui peuvent causer un mauvais fonctionnement du dispositif.

From section 7.1.4, RSS-Gen, Issue 3, December 2010, Radio Apparatus Containing Digital Circuits (ICES-003):

*“Radio apparatus containing digital circuitry which can function separately from the operation of a transmitter or an associated transmitter, shall comply with ICES-003. In such cases, the labeling requirements of the applicable RSS apply, rather than the labelling requirements in ICES-003.”*

For more information see: Industry Canada <http://www.ic.gc.ca/>

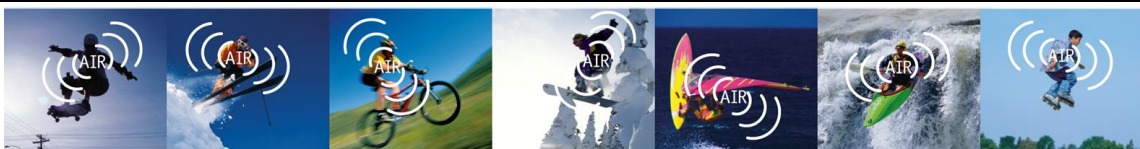

### 2.1.2.2. RF Exposure

All transmitters regulated by IC must comply with RF exposure limits as set forth in RSS-102, Issue 4, section 4, "Exposure Limits". Furthermore RSS-102, Issue 4, Section 2 "Certification Requirements", provides assistance in determining the specific requirements for compliance. If appropriate, compliance with exposure guidelines for mobile and unlicensed devices can be accomplished by the use of warning labels and by providing users with information concerning minimum separation distances from transmitting structures and proper installation of antennas.

The following statement must be included as a CAUTION statement in manuals and OEM products to alert users of IC RF Exposure compliance:

**Notice:** To satisfy Industry Canada requirements the antenna used with this transmitter must not be co-located or operating in conjunction with any other antenna or transmitter except as permitted by Industry Canada's multi-transmitter procedures

**Avis:** Pour satisfaire aux exigences d'Industrie Canada l'antenne utilisée avec cet émetteur ne doit pas être colocalisée ni de fonctionner en conjonction avec une autre antenne ou un autre émetteur, sauf dans la mesure permise par les procédures multi-émetteurs de l'Industrie Canada

### 2.1.3. Europe (Conformité Européenne, CE)

The A2541R24A and A2541R24C modules have been certified for use in European countries covered by ETSI regulations. The following tests have been performed and the module found to be compliant to the requirements:

- Test standard ETSI EN 300 328 V1.9.1 (2015-02)
  - ✓ Maximum Isotropic Radiated Power (Normal and Extreme Conditions)
  - ✓ Maximum e.i.r.p. Spectral Density
  - ✓ Frequency Range (Normal and Extreme Conditions)
  - ✓ Transmitter Spurious Emissions
  - ✓ Receiver Spurious Emissions
- Electro-Static Discharge and RF Immunity (ETSI EN 301 489-17)
- RF Exposure (ETSI EN 62311:2008)
- Safety (IEC 60950-1:2005 and EN 60950-1:2006)

A helpful document that can be used as a starting point in understanding the use of short range devices (SRD) in Europe is the European Radio Communications Committee (ERC) Recommendation 70-03 E, downloadable from the European Radio Communications Office (ERO) <http://www.ero.dk>.





The end user is responsible for ensuring compliance with harmonized frequencies and labeling requirements for each country the end device is marketed and sold.

For more information see:

- Radio And Telecommunications Terminal Equipment (R&TTE) [http://ec.europa.eu/enterprise/rtte/index\\_en.htm](http://ec.europa.eu/enterprise/rtte/index_en.htm)
- European Conference of Postal and Telecommunications Administrations (CEPT) <http://www.cept.org/>
- European Telecommunications Standards Institute (ETSI) <http://www.etsi.org/>
- European Radio Communications Office (ERO) <http://www.ero.dk/>

#### 2.1.4. Taiwan (NCC, 📶)

##### 2.1.4.1. NCC warning statement:

低功率電波輻射性電機管理辦法

第十二條經型式認證合格之低功率射頻電機，非經許可，公司、商號或使用者均不得擅自變更頻率、加大功率或變更原設計之特性及功能。

第十四條低功率射頻電機之使用不得影響飛航安全及干擾合法通信；經發現有干擾現象時，應立即停用，並改善至無干擾時方得繼續使用。前項合法通信，指依電信規定作業之無線電信。低功率射頻電機須忍受合法通信或工業、科學及醫療用電波輻射性電機設備之干擾。

##### 2.1.4.2. NCC ID warning statement:

模組認證合格標籤 (ID):

“ CCXXxxLPyyyZz ”

如果使用本模組之平台,無法在外部看見審驗合格標籤時,應在該平台的外部明顯標示

“內含射頻模組 CCXXxxLPyyyZz” .



### 2.1.5. Bluetooth Special Interest Group (SIG)

The A2541R24A and A2541R24C modules have been certified and listed as Bluetooth smart devices under the following categories:

Model Number	Type	Declaration ID	Memo
A2541R24A10	Controller Subsystem	B021836	Antenna Module Based on TI's CC2541 transceiver IC and BLE stack
A2541R24C10	Controller Subsystem	B021836	Connector Module Based on TI's CC2541 transceiver IC and BLE stack
A2541R24A20	Controller Subsystem	B021836	Antenna Module Based on TI's CC2541 transceiver IC and Emmoco's Software based on TI's Host Subsystem
	Host Subsystem	B017183	
A2541R24C20	Controller Subsystem	B021836	Connector Module Based on TI's CC2541 transceiver IC and Emmoco's Software based on TI's Host Subsystem
	Host Subsystem	B017183	

## 2.2. Potential Interference Sources

The radio modules operate in the unlicensed ISM band, in which there are many other applications e.g. WLAN, Classic Bluetooth and microwave ovens. This can cause interference that may, in certain conditions, prohibit radio communication.

Some of the most common interferences are listed below:

### 2.2.1. WLAN

Wireless Local Area Networks (WLANs) are divided into a number of overlapping channels. Figure 4 below shows the channels used by WLAN; for the US and Canada, only channels 1-13 may be used. Predominantly, channels 1, 6 and 11 are used to achieve non-overlapping channels. The user is therefore encouraged to select a channel scheme that also has channels falling in between, or entirely outside, WLAN channels. Using a detection scheme (clear channel assessment) will enable the user to find channels with minimal interference from WLAN devices.

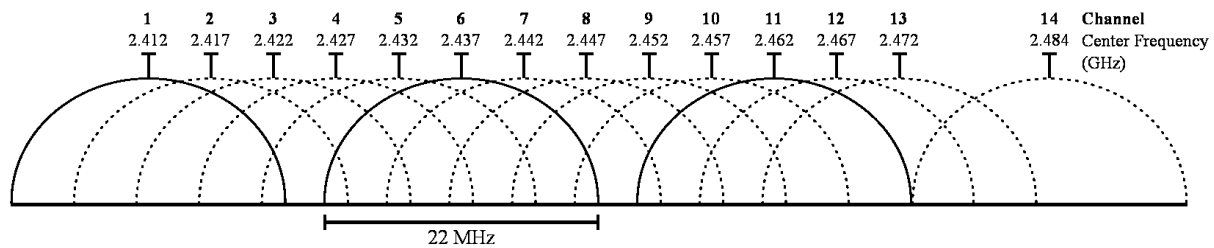

Figure 4 WLAN channels

### 2.2.2. Classic Bluetooth

Classic Bluetooth divides the 2.402-2.480 GHz band into 79 channels, each of which is 1MHz wide. However, since Bluetooth changes channels rapidly (up to 1600 times a second), it is



Anaren Integrated Radio

unlikely to cause continuous interference in a specific channel and can be overcome by implementing a simple acknowledge/retransmit functionality.

### 2.2.3. Microwave ovens

A typical microwave oven uses a self-oscillating magnetron with a duty cycle below 50%, because the tube is completely off for half of every AC mains cycle (8.33 ms in 60 Hz countries and 10 ms in 50 Hz countries). The frequency of the microwave oven changes cyclically within each AC mains synchronized on period, and is generally not predictable.

The user is encouraged to have packet transmission durations less than half the AC mains period and implement an acknowledge/retransmit method.

### 2.2.4. Other Interference

Systems similar to the user’s system may also exist within range and may also be a source of interference; some typical applications to consider are:

- Alarm systems
  - These typically use low duty cycles and are therefore easy to avoid using acknowledge/retransmit methods
- Car alarms (internal motion sensors)
- Video surveillance
  - These are typically operated on a fixed channel, determined at installation time and can be avoided by using clear channel assessment. It may be useful to change the channel used by the video surveillance equipment also, if possible.

### 2.2.5. Time critical data

If the user requires specific time critical data throughput that cannot tolerate the delays of potentially many re-transmissions, the user is encouraged to implement an environment-aware algorithm that periodically monitors/scans the frequency band and maintains a list of “best available” channels.



## 2.3. Approved Usage

The A2541R24A and A2541R24C modules have been approved for use in the US, Canada and Europe. The user is encouraged to use minimum power required to establish a link, thus minimizing interference.

Changes or modifications to the module and/or operation outside the limits are prohibited and could void the user's authority to operate the modules.

### 2.3.1. USA and Canada

Within the USA and Canada, the A2541R24A and A2541R24C modules have been approved for use as digitally modulated transmitters, for which they conform to the BW (a minimum of 500 kHz 6-dB BW for US, a maximum BW of 0.5% of the carrier frequency for Canada), power spectral density (max of 8 dBm / 3 kHz), total output power (max of 1W including the antenna gain) and spurious radiation (harmonics and others including the restricted bands) requirements.

Table 2 shows approved modulation types and frequencies of operations with the corresponding maximum output power values and PA\_Table register settings. These modules must be operated at or below the indicated power levels. Using the modules with higher power levels are prohibited, and will void the user's authority to operate the modules under current FCC/IC certification.

Table 3 shows available power levels from the device along with the corresponding PA\_Table register settings. Users are encouraged to use minimum power required to establish a link, thus minimizing interference and current consumption.

*Table 2 Approved Modulation Types and Power Levels for FCC/IC and ETSI*

Approved Modulation Types	Frequency band of operation (MHz)	Max Allowed Power (dBm)	PA_Table Value (Hex)
GFSK 2Mbps,500kHz Deviation	2402 - 2480	+1	0xEF
GFSK 2Mbps, 320kHz Deviation	2402 - 2480	+1	0xEF
GFSK 1Mbps, 250kHz Deviation	2402 - 2480	+1	0xEF
GFSK 1Mbps, 160kHz Deviation	2402 - 2480	+1	0xEF
GFSK 250kbps, 160kHz Deviation	2402 - 2480	+1	0xEF
MSK 500kbps	2402 - 2480	+1	0xEF
MSK 250kbps ( <b>ETSI only</b> )	2402 - 2480	+1	0xEF



Anaren Integrated Radio

Table 3 Output Power vs. PA Table Value (tolerance +/- 1.5 dB)

Power (dBm)	PA_Table Value [Hex]
1.0	0xEF
0.0	0xE1
-1.5	0xD1
-3.0	0xC1
-5.0	0xB1
-7.0	0xA1
-9.5	0x91
-11.0	0x81
-13.5	0x71
-15.0	0x61
-17.0	0x51
-19.0	0x41
-21.0	0x31
-23.0	0x21
-25.0	0x11
-27.0	0x01

### 2.3.2. Europe

For Europe, the maximum allowed output power is 100mW with a spectral power density limit of 10mW/MHz. A2541R24A and A2541R24C modules comply with the power spectral density requirements at their highest power level, therefore approved power levels given in Table 2 apply. Please refer Table 3 for the available power levels from this module.

### 2.3.3. Bluetooth

End products using A2541R24A or A2541R24C modules should have their own *End Product Listing* (EPL) through Bluetooth SIG in order to be advertised as Bluetooth smart compliant. Please check the easy-to-follow guide located at <http://www.bluetooth.org> for more information.



## 3. Electrical Characteristics

### 3.1. Absolute Maximum Ratings

Under no circumstances shall the absolute maximum ratings given in Table 4 be violated. Stress exceeding one or more of the limiting values may cause permanent damage to the device.

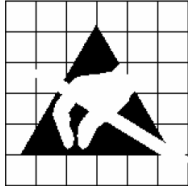

Caution!  
ESD sensitive device. Precaution should be used when handling the device in order to prevent permanent damage.



Caution!  
This assembly contains moisture sensitive devices and requires proper handling per IPC/JEDEC J-STD-033

Table 4 Absolute Maximum Ratings

Parameter	Min	Max	Unit	Condition/Note
Supply Voltage (Vdd)	-0.3	3.9	V	
Voltage on any digital pin	-0.3	Vdd+0.3, max 3.9	V	
RF input power		10	dBm	
Storage Temperature	-40	125	°C	
Solder reflow temperature		260	°C	According to IPC/JEDEC J-STD-020D
ESD		2	kV	According to JEDEC STD 22, method A114, Human body model
ESD		500	V	According to JEDEC STD 22, C101, Charged Device Model (CDM)



Anaren Integrated Radio

### 3.2. Operating Conditions

Table 5 Operating conditions

Parameter	Min	Max	Unit	Condition/Note
Supply Voltage (Vdd)	2	3.6	V	
Temperature Range	-40	+85	°C	

### 3.3. Pin Out

The A2541R24A and A2541R24C radios share a common pin-out and foot print, thus enabling the use of the same application PCB layout for US/Europe and low power (short range) versus higher power (long range). Depending on the firmware inside the module, pin functionalities change.

#### 3.3.1. A2541R24x10 (Module with TI BLE Stack)

A module with no firmware will show the references to the native CC2541 transceiver chip and any additional functions added to it. Below the pin-out is shown:

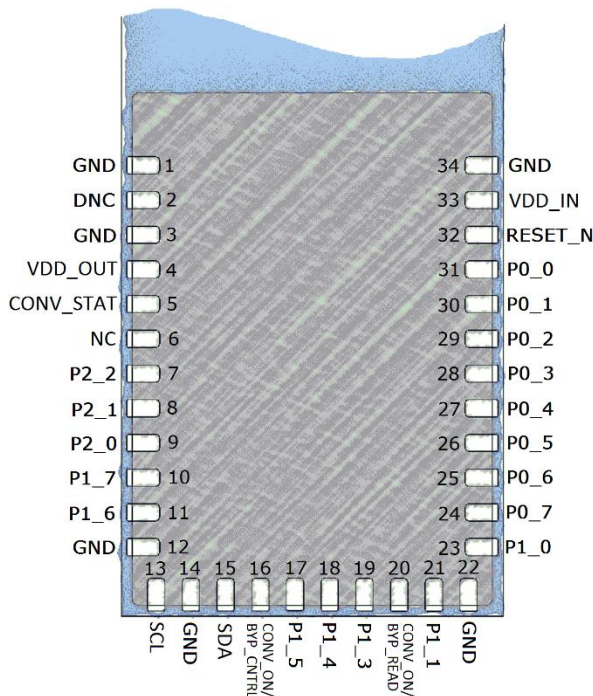

Where applicable:

**NC = “NO Connection”.** Pin is NOT connected internally.

**DNC = “Do Not Connect”.** Pin reserved for internal use, ensure mating footprint pads are **isolated**.

**GND = “Ground”.** Connect the maximum number possible (minimum **one** for proper operation).

Figure 5 A2541R24x10 Module pin-out (viewed from top side)



Table 6 A2541R24x10 pin descriptions with references to chip pins

Pin Number	Pin Name	Pin Type	Description	TPS62730 PIN	CC2541 PIN
1, 3, 12, 14, 22, 34	GND	Common Ground	Connect to GND		
2	DNC		<b>Do Not</b> Connect. Connecting this pin to anything will significantly affect the performance of the module and may <b>void</b> the end users right, under FCC, to operate the module		
4	VDD_OUT	Power (Analog)	DC-DC Converter Vout. 2.1V when converter is ON, VDD_IN when in BYPASS mode. Up to 75mA drive capability	6	
5	CONV_STAT	Digital Output	DC-DC Converter Status pin. Open-drain with a 3.3kΩ series resistor	1	
6	NC		Pin is not internally connected		
7 - 9	P2_2 - P2_0	Digital I/O	General-purpose digital I/O pin Port 2.2 - Port 2.0		34 - 36
10 - 11	P1_7 - P1_6	Digital I/O	General-purpose digital I/O pin Port 1.7 - Port 1.6		37 - 38
17 - 19	P1_5 - P1_3	Digital I/O	General-purpose digital I/O pin Port 1.5 - Port 1.3		5 - 7
21, 23	P1_1, P1_0	Digital I/O	General-purpose digital I/O pin Port 1.1 and Port 1.0		9, 11
24 - 31	P0_7 - P0_0	Digital I/O	General-purpose digital I/O pin Port 0.7 - Port 0.0		12 - 19
13	SCL	I <sup>2</sup> C clock	Can be used as I <sup>2</sup> C clock or digital I/O. Leave floating if not used. If grounded disable pull up		2
15	SDA	I <sup>2</sup> C data	Can be used as I2C data or digital I/O. Leave floating if not used. If grounded disable pull up		3
16	CONV_ON/ BYP_CNTRL	Digital Input	DC-DC Converter ON or Bypass control input. Logic 0 for bypass, logic 1 for converter ON There is a 1 MΩ resistor between pin 16 and pin 20	5	
20	CONV_ON/ BYP_READ	Digital Output	CC2541 Port 1.2 status read. There is a 1 MΩ resistor between pin 16 and pin 20		8
32	RESET_N	Digital input	Reset, active-low, see datasheet for implementation		20
33	VDD_IN	Power (Analog)	Analog power supply connection for the Radio (2.0V to 3.6V) through DC-DC converter	3	





### 3.3.2. Pinout

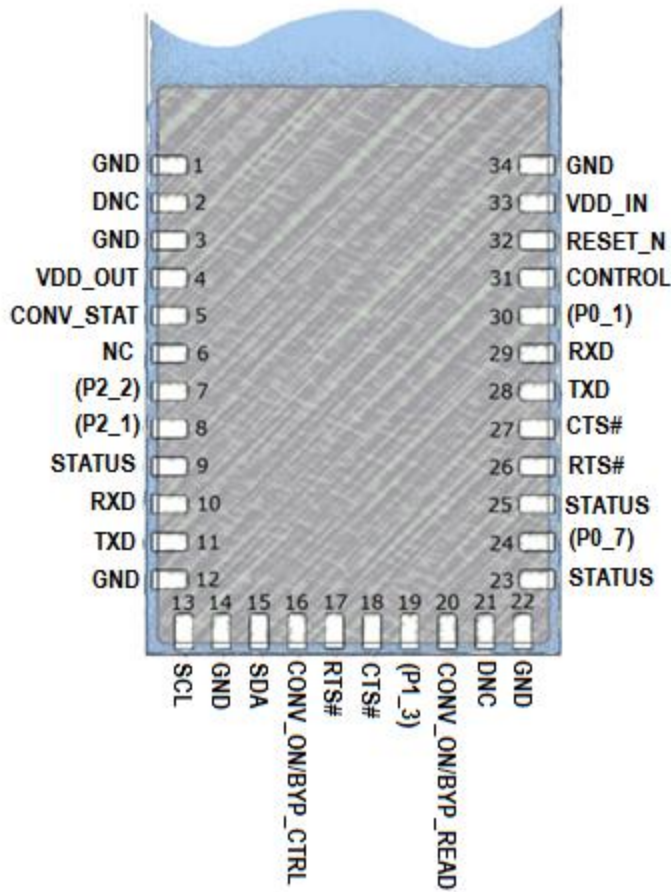

Where applicable:

**NC = “NO Connection”.** Pin is NOT connected internally.

**DNC = “Do Not Connect”.** Pin reserved for internal use, ensure mating footprint pads are **isolated**.

**GND = “Ground”.** Connect the maximum number possible (minimum **one** for proper operation).

References in (parentheses) show native CC2541 pin function. These pins are configured as inputs, and are not utilized by the firmware.

Figure 6 A2541R24x10 Module pin-out (viewed from top side)

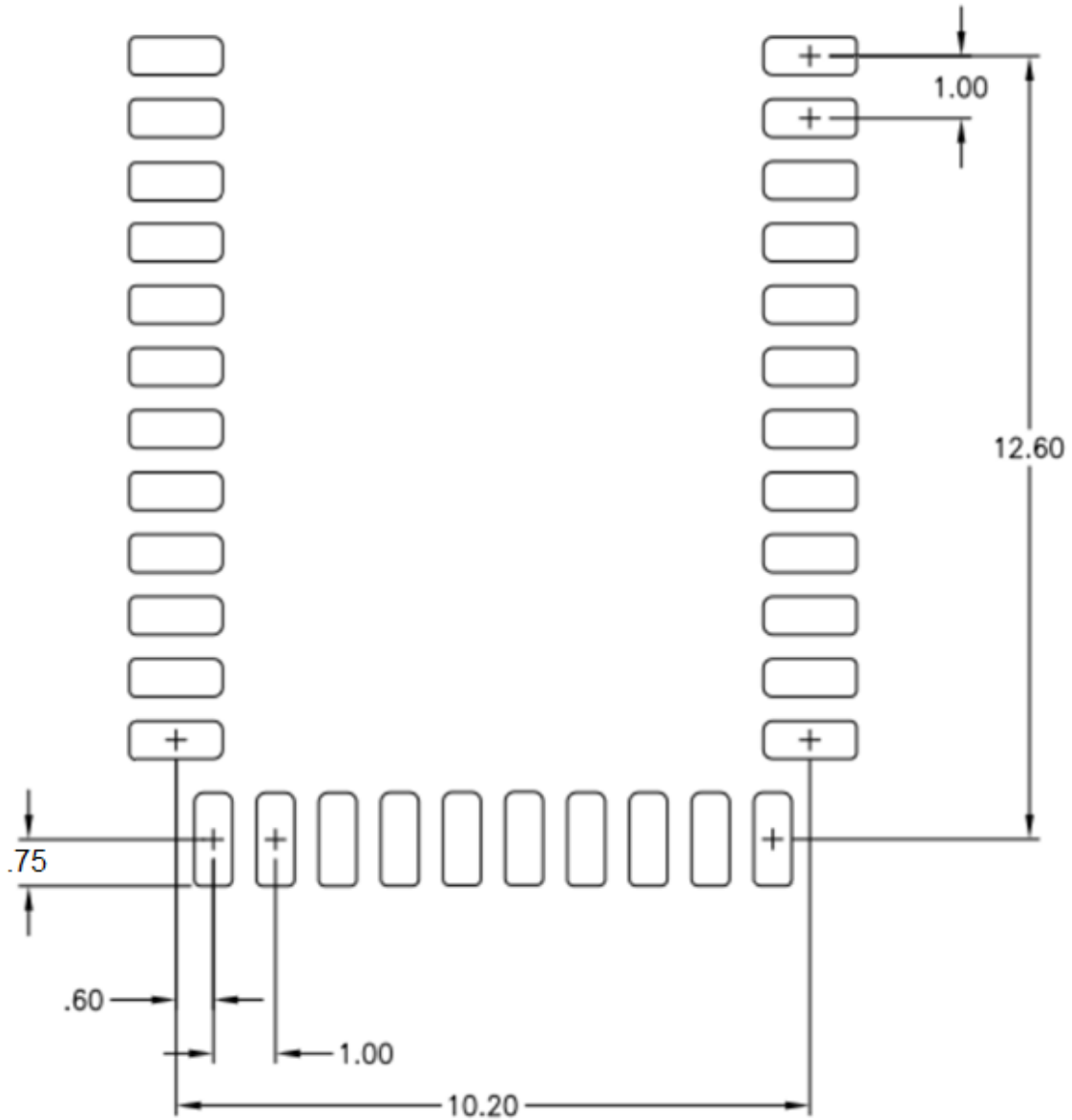

Table 7 A2541R24x10 pin descriptions with references to chip pins

Pin Number	Pin Name	Pin Type	Description	TPS62730 PIN	CC2541 PIN
1, 3, 12, 14, 22, 34	GND	Common Ground	Connect to GND		
2	DNC		<b>Do Not</b> Connect. Connecting this pin to anything will significantly affect the performance of the module and may <b>void</b> the end users right, under FCC, to operate the module		
4	VDD_OUT	Power (Analog)	DC-DC Converter Vout. 2.1V when converter is ON, VDD_IN when in BYPASS mode. Up to 75mA drive capability	6	
5	CONV_STAT	Digital Output	DC-DC Converter Status pin. Open-drain with a 3.3kΩ series resistor	1	
6	NC		Pin is not internally connected		
7	(P2_2)	Digital I/O	Not used. Internal pullup is enabled		34
8	(P2_1)	Digital I/O	Not used. Internal pullup is enabled		35
9, 23, 25	STATUS	Digital I/O	Status outputs that can be used to drive LEDs or MCU GPIOs		36, 11, 13
10	RXD	Digital I/O	Admin UART RXD pin. Requires external pullup if not always driven by an external UART device.		37
11	TXD	Digital I/O	Admin UART TXD pin		38
13	SCL	I <sup>2</sup> C clock	Can be used as I <sup>2</sup> C clock or digital I/O. Leave floating if not used. If grounded disable pull up		2
15	SDA	I <sup>2</sup> C data	Can be used as I <sup>2</sup> C data or digital I/O. Leave floating if not used. If grounded disable pull up		3
16	CONV_ON/ BYP_CNTRL	Digital Input	DC-DC Converter ON or Bypass control input. Logic 0 for bypass, logic 1 for converter ON There is a 1 MΩ resistor between pin 16 and pin 20	5	
17	RTS#	Digital I/O	Admin UART RTS pin		5
18	CTS#	Digital I/O	Admin UART CTS pin. Requires external pullup if not always driven by an external UART device.		6
19	(P1_3)	Digital I/O	Not used. Internal pullup is enabled		7
20	CONV_ON/ BYP_READ	Digital Output	CC2541 Port 1.2 status read. There is a 1 MΩ resistor between pin 16 and pin 20		8
21	DNC	Digital I/O	Do Not Connect. This pin is driven low by the firmware.		9
24	(P0_7)	Digital I/O	Not used. Internal pullup is enabled		12
26	RTS#	Digital I/O	Communication UART RTS pin		14
27	CTS#	Digital I/O	Communication UART CTS pin		15
28	TXD	Digital I/O	Communication UART TXD pin		16
29	RXD	Digital I/O	Communication UART RXD pin		17
30	(P0_1)	Digital I/O	Not used. Internal pullup is enabled		18
31	CONTROL	Digital I/O	Control Input. Internal pullup is enabled		19
32	RESET_N	Digital input	Reset, active-low, see datasheet for implementation		20
33	VDD_IN	Power (Analog)	Analog power supply connection for the Radio (2.0V to 3.6V) through DC-DC converter	3	



### 3.4. Recommended Layout (dimensions in mm)



## Footprint (PWB)

Figure 7 Recommended PCB footprint.



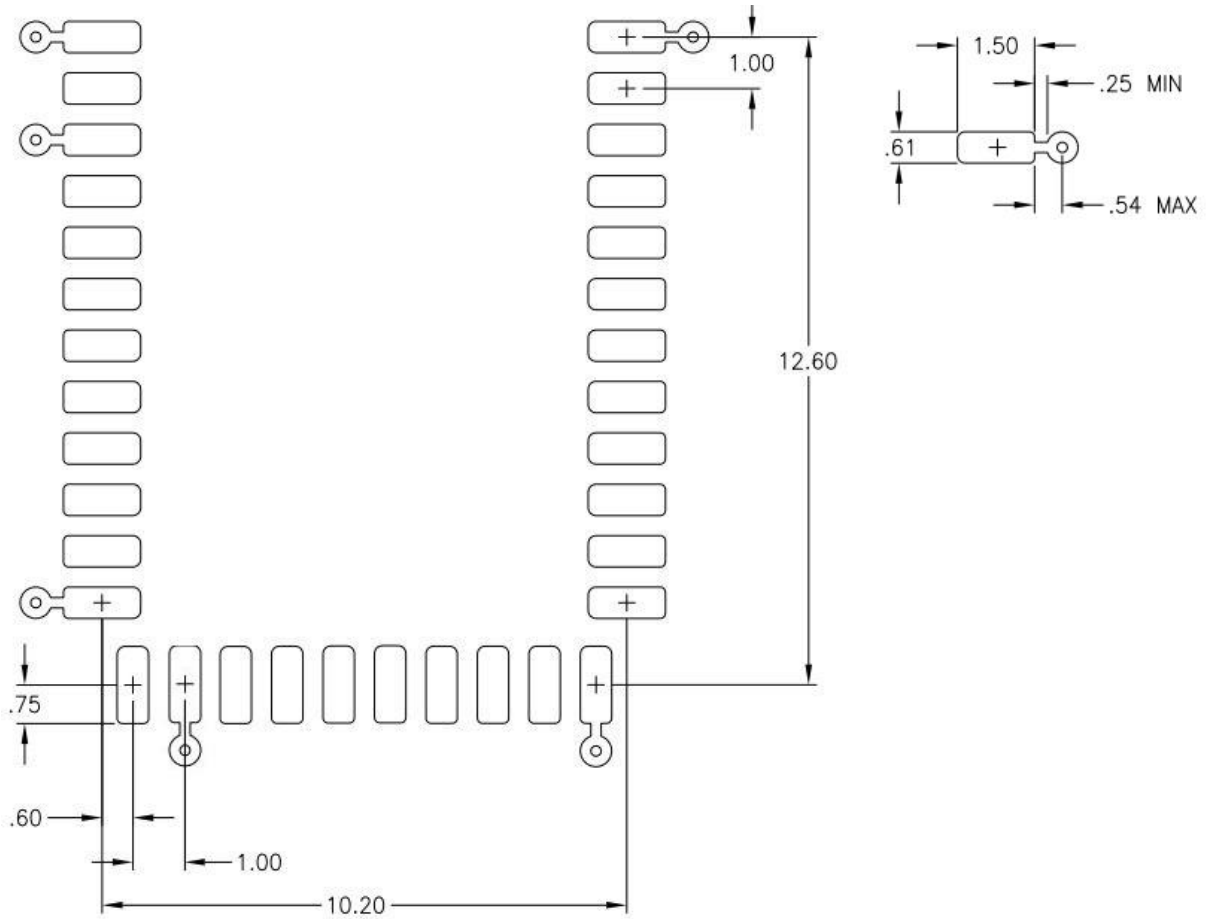

Figure 8 Recommended Layout for GND vias



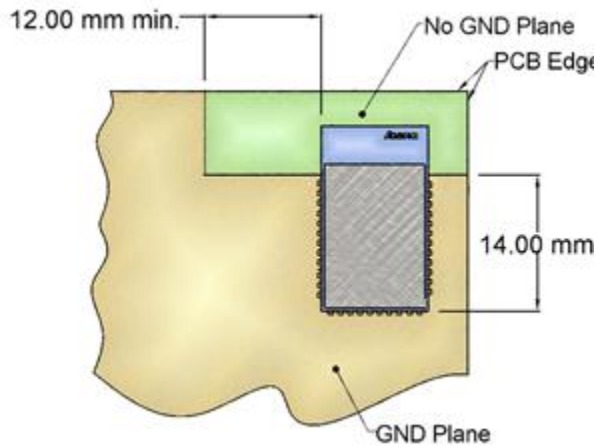

Figure 9 Mounting the module in a corner

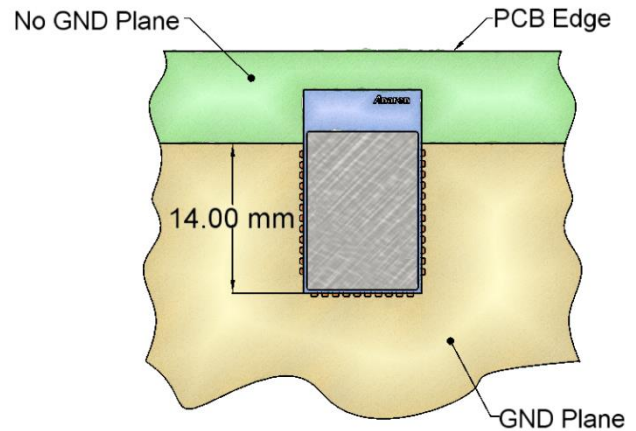

Figure 10 Mounting the module along an edge

“No GND” area is optional for A2541R24C modules. It may still be provided for compatibility with the internal antenna version (A2541R24A).

### 3.5. Power Supply Considerations

Noise on the power supply line reduces the sensitivity of a receiver and can modulate onto a transmitters signal, both of which causes a degradation of link quality and hence a reduction in range.

The A2541R24A and A2541R24C modules have integral noise reduction from power supply to the internal AVDD and DVDD pins, consisting of ferrite beads and decoupling capacitances. This arrangement will take care of most supply voltage noise. For optimal performance in particular noisy environments (switching regulators, motor controls, etc.) it may be necessary to add additional noise reduction means, which can consist of a low noise LDO or additional LC filtering.

Note that if operated from a battery source there is no need for additional noise reduction. Also note that if the noise source can be synchronized to be off whenever the module is transmitting or receiving then that will also suffice.



# 4. Mechanical and Process

## 4.1. Radio Module Details (dimensions in mm)

### 4.1.1. A2541R24A

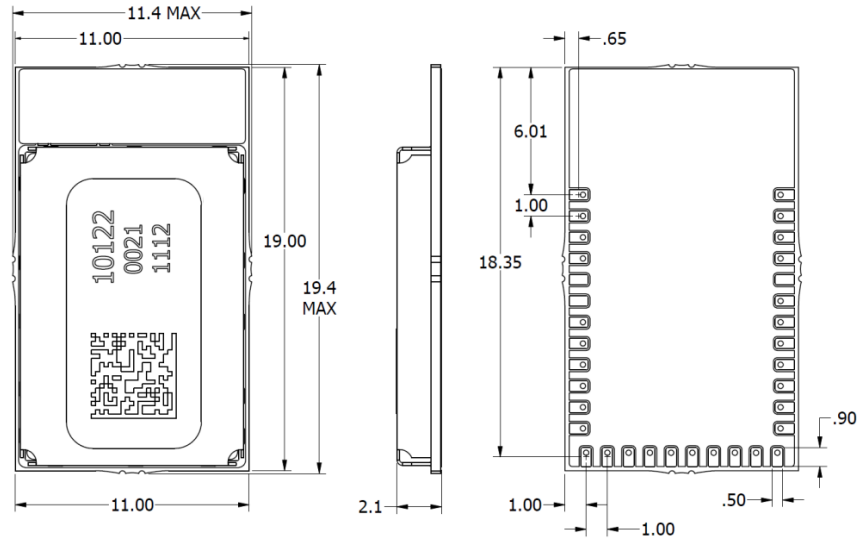

Figure 11 A2541R24A dimensions

### 4.1.2. A2541R24C

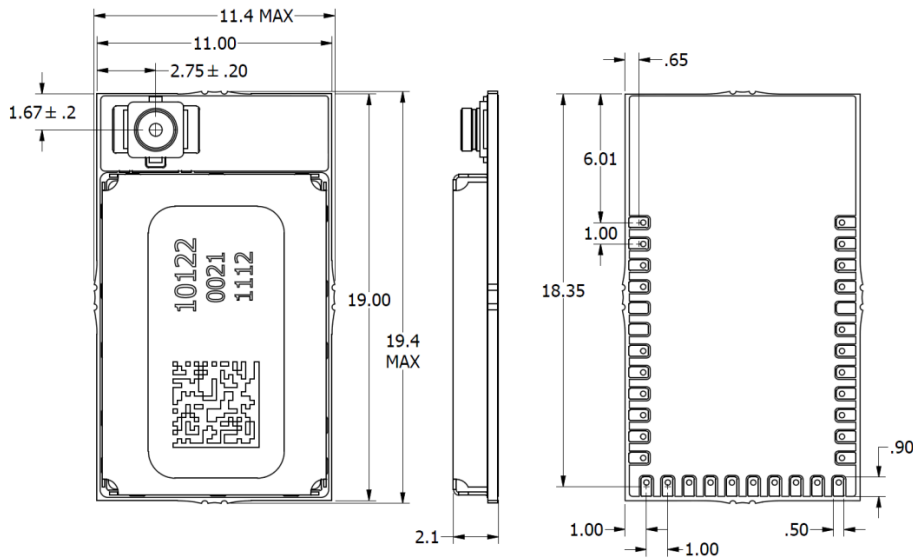

Figure 12 A2541R24C dimensions



## 4.2. Packaging Details (dimensions in mm)

AIR modules are available in Matrix Tray and Tape & Reel packaging for high-volume assembly. Details of packaging provided below:

### 4.2.1. Matrix Tray Packaging

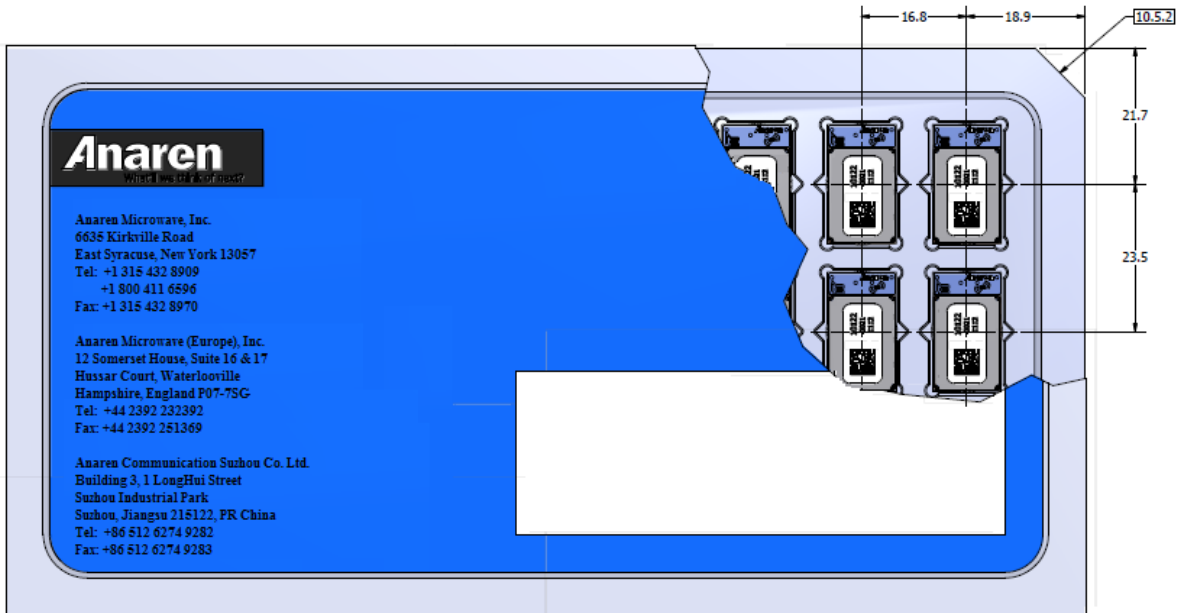

Figure 13 A2541R24AxxGM and A2541R24CxxGM Matrix Tray Packaging Detail (27/Tray)

### 4.2.2. Tape-Reel Packaging

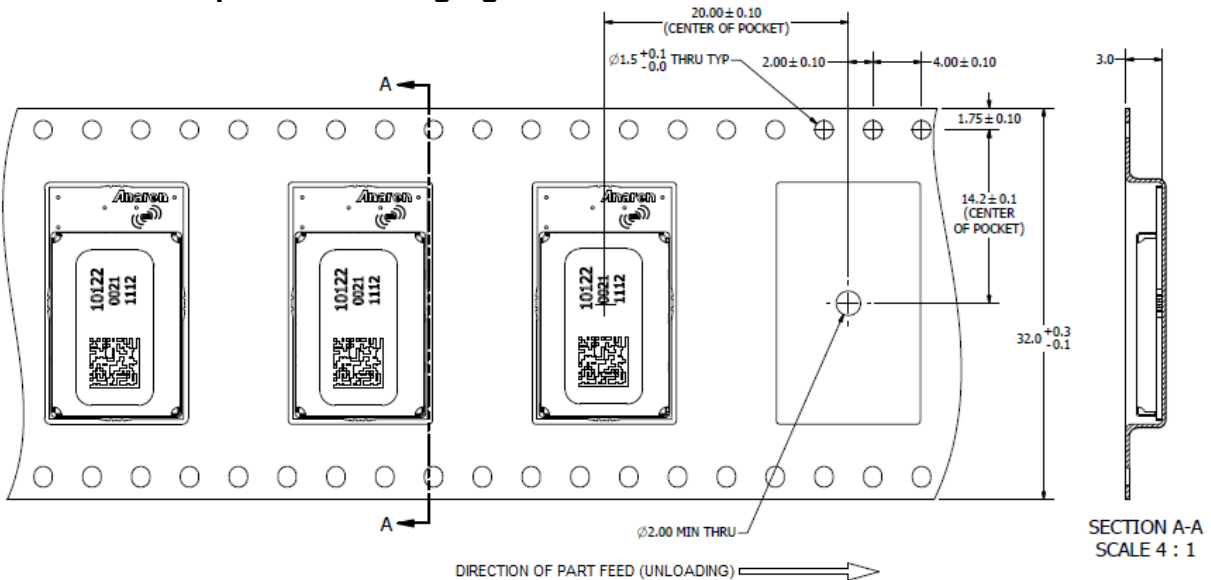

Figure 14 A2541R24AxxGR and A2541R24CxxGR Tape-Reel Packaging Detail (500/Reel)



## 4.3. Soldering

AIR Modules may be mounted either manually (for prototyping or low volume production), or automatically for high-volume production.

A no-clean tin/silver/copper (SAC) solder is recommended, however lead based no-clean pastes may also be used.

**CAUTION:** AIR Modules are designed for no-clean fluxes only. DO NOT use water-based fluxes that require aqueous cleaning after solder. Spot cleaning with a flux remover and toothbrush may be performed with care.

### 4.3.1. Manual Mounting Procedure

The recommended soldering method is reflowing of a paste solder on a hot plate. This method works provided the bottom of the board where the AIR module is to be mounted is accessible, and there are no bottom-side components in the way.

An aluminum or copper block may be placed on the hot plate surface to transfer heat to a localized area on the board where the AIR module is mounted

- Set the hot plate to the reflow temperature solder manufacturer's recommended
- Apply solder paste to the pads on the board receiving the AIR module
- Place the AIR module carefully onto the dispensed solder
- Using tweezers or another holding device, carefully place board with AIR module onto the hot plate surface (or metal block)
- Apply heat until reflow occurs, per solder paste manufacturer's recommendations
- Carefully remove the board and place on a heat-resistant surface to cool
- Check assembly electrically to confirm there are no opens or shorts





### 4.3.2. Automated Mounting Procedure

The AIR Radio Module recommended solder reflow profile is based on IPC/JEDEC J-STD-020.

Table 5-2 Classification Reflow Profiles

Profile Feature	Sn-Pb Eutectic Assembly	Pb-Free Assembly
Average ramp-up rate (T <sub>smax</sub> to T <sub>p</sub> )	3° C/second max.	3° C/second max.
<b>Preheat</b>		
- Temperature Min (T <sub>smin</sub> )	100 °C	150 °C
- Temperature Max (T <sub>smax</sub> )	150 °C	200 °C
- Time (T <sub>smin</sub> to T <sub>smax</sub> ) (t <sub>s</sub> )	60-120 seconds	60-180 seconds
Time maintained above:		
- Temperature (T <sub>L</sub> )	183 °C	217 °C
- Time (t <sub>L</sub> )	60-150 seconds	60-150 seconds
Peak Temperature (T <sub>p</sub> )	See Table 4.1	See Table 4.2
Time within 5°C of actual Peak Temperature (t <sub>p</sub> ) <sup>2</sup>	10-30 seconds	20-40 seconds
Ramp-down Rate	6 °C/second max.	6 °C/second max.
Time 25°C to Peak Temperature	6 minutes max.	8 minutes max.

**Note 1:** All temperatures refer to topside of the package, measured on the package body surface.

**Note 2:** Time within 5 °C of actual peak temperature (t<sub>p</sub>) specified for the reflow profiles is a “supplier” minimum and “user” maximum.

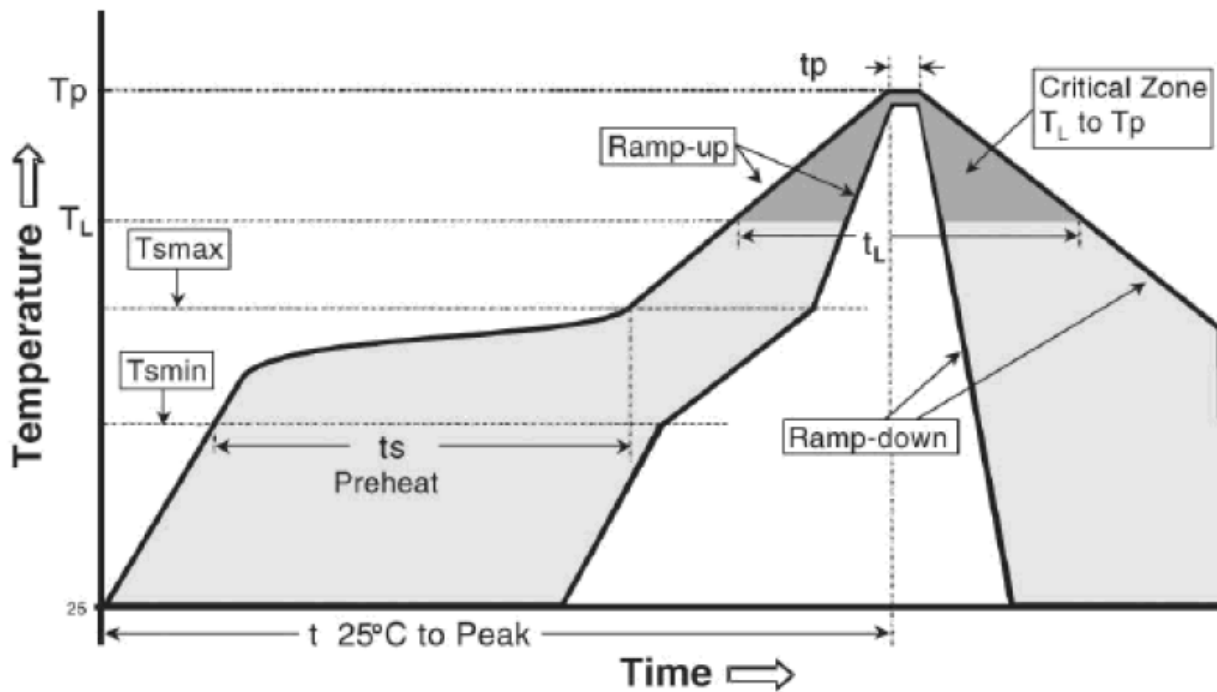

Classification Reflow Profile



**SnPb Eutectic Process - Package Peak Reflow Temperatures**

Package Thickness	Volume mm <sup>3</sup> <350	Volume mm <sup>3</sup> ≥ 350
<2.5 mm	240 +0/-5 °C	225 +0/-5 °C
≥ 2.5 mm	225 +0/-5 °C	225 +0/-5 °C

**Pb-free Process - Package Peak Reflow Temperatures**

Package Thickness	Volume mm <sup>3</sup> < 350	Volume mm <sup>3</sup> 350 - 2000	Volume mm <sup>3</sup> > 2000
< 1.6 mm	260 °C *	260 °C *	260 °C *
1.6 mm - 2.5 mm	260 °C *	250 °C *	245 °C *
> 2.5 mm	250 °C *	245 °C *	245 °C *

\* Tolerance: The device manufacturer/supplier shall assure process compatibility up to and including the stated classification temperature at the rated MSL level



## DOCUMENT HISTORY

Date	Author	Change Note No./Notes
05/16/13	Sula	Initial Draft
05/19/13	Richardson	Updated RF Exposure
05/22/13	Richardson	Updated RF Exposure
06/03/13	Richardson	Updated multiple sections
10/14/13	Sula	Updated multiple sections
10/28/13	Sula	Added info about DC-DC converter operation, updated multiple sections and figures
11/22/13	Sula	Added subsections 2.1.4 and 2.3.3.
01/07/14	Richardson	Added Taiwan (NCC) Approval
11/14/2016	Subramanian	Removed 20 version and Emmoco references
11/14/2016	Subramanian	Updated EN 300 328 version to V1.9.1



Attach distributor contact information  
here

If you have additional questions, need samples, or would like a quote –  
please email the AIR team at [AIR@anaren.com](mailto:AIR@anaren.com) .

For a full list of our franchised distributors, please visit our website:  
<http://www.anaren.com/air/>



---

**Anaren Microwave, Inc.**  
6635 Kirkville Road  
East Syracuse, NY 13057  
Tel: +1 315 432 8909  
+1 800 411 6596  
Fax: +1 315 432 8970

**Anaren Microwave (Europe), Inc.**  
12 Somerset House, Suite 16 & 17  
Hussar Court, Waterlooville  
Hampshire, England P07-7SG  
Tel: +44 2392 232392  
Fax: +44 2392 251369

**Anaren Communication Suzhou Co. Ltd.**  
Bldg 3, No. 1 LongHui Street  
Suzhou Industrial Park  
Suzhou 215122, PR China  
Tel: +86 512 6274 9282  
Fax: +86 512 6274 9283

---