

# LE8N Series

## DIN W48×H24mm, Indication Only, LCD Timer (Hour Meter)

### ■ Features

- No additional power due to internal battery
- Signal input method: No-voltage input, voltage input, free voltage input
- Screw terminal type (attaching terminal cover)
- LCD display, backlight model
- Protection structure: IP66



**⚠ Please read "Safety Considerations" in the instruction manual before using.**



### ■ Ordering Information

<b>LE</b>	<b>8</b>	<b>N</b>	<b>-</b>	<b>B</b>	<b>N</b>	<b>-</b>	<b>L</b>	
Item	Digit	Size		Power supply	Input type		Backlight	
								No mark
								None
								L
								Backlight function
								N
								No-voltage (small signal) input
								V
								Voltage input
								F
								Free voltage input
								B
								Internal lithium battery
								N
								DIN W48×H24mm
								8
								99999999 (8-digit)
								LE
								Compact LCD Timer

### ■ Specifications

Model	LE8N-BN	LE8N-BN-L	LE8N-BV	LE8N-BV-L	LE8N-BF
Digit	8-digit (0 to 99999999)				
Digit size	W3.4×H8.7mm				
Display method	LCD Zero Blanking type (character height size: 8.7mm)				
Operation method	Count up				
Power supply	Built-in battery				
Battery life cycle	Approx. over 10 years at 20°C				
Backlight power supply	—	24VDC $\pm$ 10%	—	24VDC $\pm$ 10%	—
Input method	No-voltage input		Voltage input		Free voltage input
START input	Residual voltage: max. 0.5VDC $\pm$ Short-circuit impedance: max. 10k $\Omega$ Open-circuit impedance: min. 750k $\Omega$		[H]: 4.5-30VDC $\pm$ [L]: 0-2VDC		[H]: 24-240VAC $\sim$ /6-240VDC $\pm$ [L]: 0-2VAC/0-2.4VDC
RESET input	No-voltage input		Voltage input		No-voltage input
Min. input signal width	SIGNAL, RESET input: approx. 20ms				
Time specification (TS1)	99999999 (h.m.s), 99999999 (h.m), 99999999 (h.m)				
Time specification (TS2)	99992359 (d.h.m), 9999d239 (d.h), 99999999 (s)				
Time specification (TS3)	9999h599 (h.m), 99999h59 (h.m), 9999999h (h)				
Time error, Temperature error	$\pm$ 0.01%				
External set switch	SW1 $\times$ 1, SW2 $\times$ 2, SW3 $\times$ 3				
Insulation resistance	Over 100M $\Omega$ (at 500VDC megger)				
Dielectric strength $\times$ 4	2,000VAC 60Hz for 1 min				
Vibration	Mechanical	0.75mm amplitude at frequency of 10 to 55Hz (for 1 min) in each X, Y, Z direction for 1 hour			
	Malfunction	0.3mm amplitude at frequency of 10 to 55Hz (for 1 min) in each X, Y, Z direction for 10 min			
Shock	Mechanical	300m/s $^2$ (approx. 30G) in each X, Y, Z direction for 3 times			
	Malfunction	100m/s $^2$ (approx. 10G) in each X, Y, Z direction for 3 times			
Environment	Ambient temp.	-10 to 55°C, storage: -25 to 65°C			
	Ambient humi.	35 to 85%RH, storage: 35 to 85%RH			
Protection structure	IP66 (when using waterproof rubber for front panel, IEC standard)				
Accessory	Mounting bracket, Rubber waterproof ring				
Approval	CE cULUS				
Weight $\times$ 5	Approx. 96g (approx. 50g)				

$\times$ 1: SW1 is the front panel RESET key enable/disable set switch.

$\times$ Environment resistance is rated at no freezing or condensation.

$\times$ 2: SW2 is the time range set switch.

$\times$ 3: SW3 is available to select time specification TS1, TS2, or TS3.

$\times$ 4: No-voltage input, voltage input: between terminals and the case/Free voltage input: between the free voltage input terminal and the RESET input terminal, between terminals and the case

$\times$ 5: The weight includes packaging. The weight in parenthesis is for unit only.

# Compact LCD Display Timer

## ■ Connections

Input type	No-backlight	Backlight function
No-voltage input type	<p>●LE8N-BN<sup>※1</sup></p>	<p>●LE8N-BN-L<sup>※2</sup></p>
Voltage input type	<p>●LE8N-BV<sup>※1</sup></p>	<p>●LE8N-BV-L<sup>※2</sup></p> <p>※Backlight power is available as signal input and reset.</p>
Free voltage input type	<p>●LE8N-BF</p> <p>※Terminal (1, 2) and (4, 5) are insulated inside.</p>	

※1: Terminal 2 and 5 are connected inside. (non-isolated)

※Use reliable contacts enough to flow 5 $\mu$ A current.

※2: Terminal (1, 2, 3) and (4, 5) are insulated inside.

## ■ Dimensions

(unit: mm)

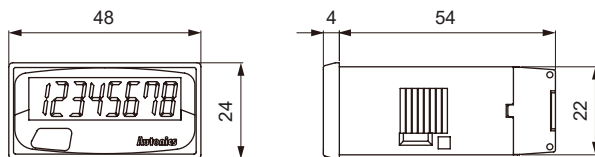

### ◎ Bracket

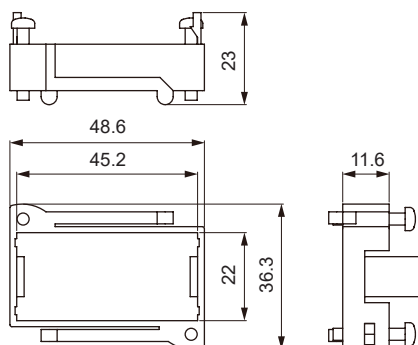

### ◎ Panel cut-out

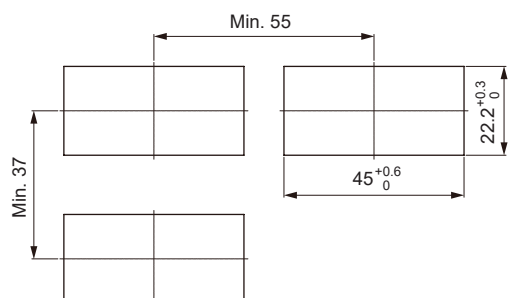

SENSORS

CONTROLLERS

MOTION DEVICES

SOFTWARE

(J) Temperature Controllers

(K) SSRs

(L) Power Controllers

(M) Counters

(N) Timers

(O) Digital Panel Meters

(P) Indicators

(Q) Converters

(R) Digital Display Units

(S) Sensor Controllers

(T) Switching Mode Power Supplies

(U) Recorders

(V) HMIs

(W) Panel PC

(X) Field Network Devices

# LE8N Series

## Input Connections

### No-voltage input (standard sensor: NPN open collector output type)

#### Solid-state input

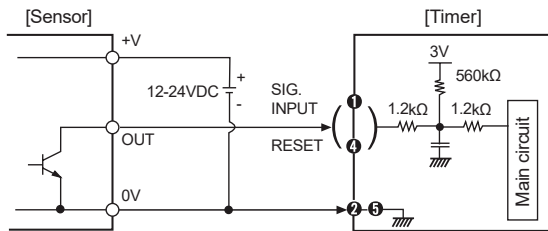

※When power is applied to terminal No ① and ④, input terminal circuit can be broken and a malfunction can occur. (NPN output, PNP output, PNP open collector output type sensor cannot be used.)

※② and ⑤ are connected inside.

※For backlight function model, the input terminals are ①, ③ and the GND terminal is ②.

### Voltage input (standard sensor: PNP open collector output type)

#### Solid-state input

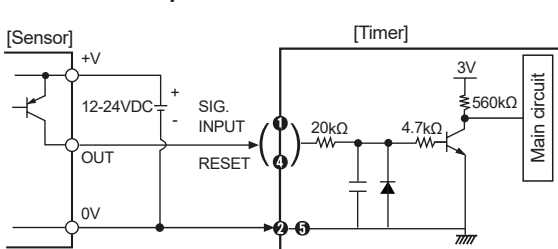

※For backlight function model, the input terminals are ①, ③ and the GND terminal is ②.

### Free voltage input

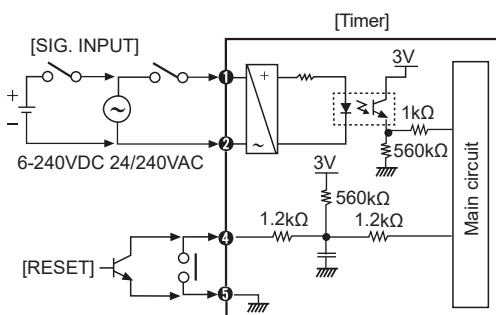

#### Contact input

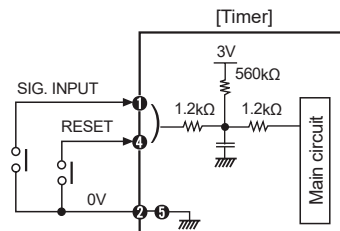

※Please use reliable contacts enough to flow 3VDC 5μA of current.

#### Contact input

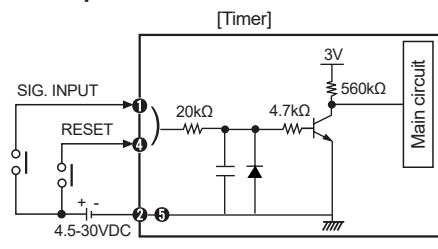

※Use reliable contacts enough to flow 3VDC 5μA of current.

※AC type proximity sensor cannot be used as the source of input signals.

※Input terminal (①, ②) and reset terminal (④, ⑤) are insulated inside.

※It is not possible to reset with AC power or DC power.

※When relay contact is used as the source of RESET signal, please use reliable contacts enough to flow 3VDC 5μA of current.

### Input from AC type proximity sensor

In case of free voltage input type, do not connect AC proximity sensors instead of a switch as shown in the figure 1. It may cause malfunction due to sensor's leakage current. Connect a relay as shown in the figure 2.

(Figure 1)

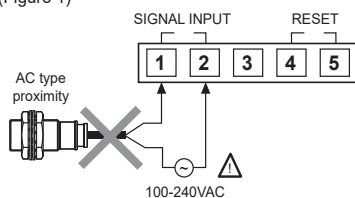

<example of wrong connection>

(Figure 2)

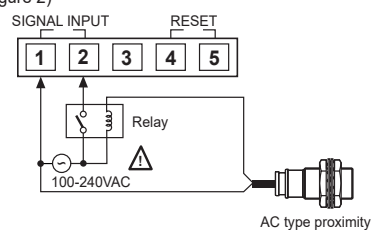

<example of correct connection>

# Compact LCD Display Timer

## Set Switch

### SW1 setting ( 1 switch )

SW1 is a switch to Enable/Disable the front panel RESET key.  
 ※Factory default: Enable

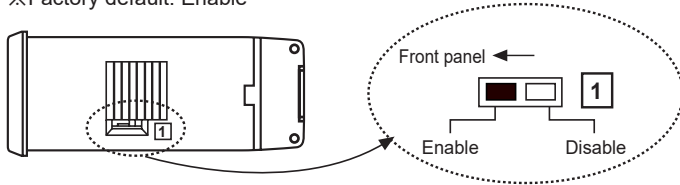

### SW2 setting ( 2 switch )

SW2 is a switch for setting time range.  
 ※Factory default: 9999.59.59 (h.m.s)

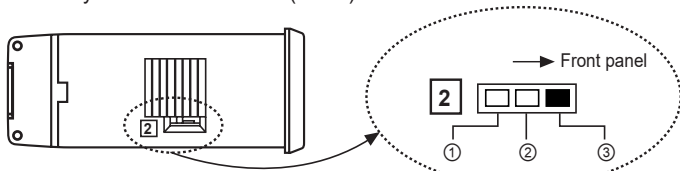

※Refer to "<Time range>" table of SW3 for ①, ②, ③ descriptions.

### SW3 setting

SW3 is a switch for setting time specification. TS1, TS2, TS3 (※Factory default: TS1)

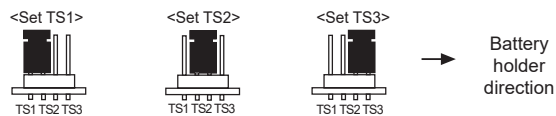
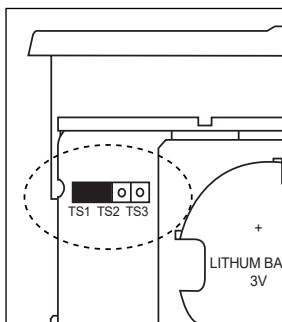

<Time range>※1

	TS1	TS2	TS3
①	hour. min. 9999.99.59	sec. 9999.9999	hour. 9999.99.9h
②	hour. min. 9999.59.59	day. hour 9999.d2.39	hour. min. 9999.h5.9
③	hour. min. sec. 9999.59.59	day. hour. min. 9999.2.3.59	hour. min. 9999.h5.9.9

※1: Time range is set as SW2, SW3 combination.

## Time Operation

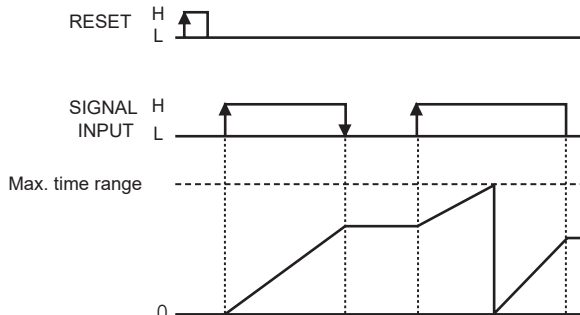

SENSORS

CONTROLLERS

MOTION DEVICES

SOFTWARE

(J) Temperature Controllers

(K) SSRs

(L) Power Controllers

(M) Counters

(N) Timers

(O) Digital Panel Meters

(P) Indicators

(Q) Converters

(R) Digital Display Units

(S) Sensor Controllers

(T) Switching Mode Power Supplies

(U) Recorders

(V) HMIs

(W) Panel PC

(X) Field Network Devices

# LE8N Series

## ■ Case Detachment and Battery Replacement

### ◎ Case detachment

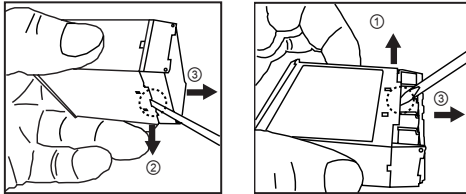

※Hold up Lock part toward ①, ② of the product with the tool and pull toward ③ to detach the case.

⚠When using the tools, be careful not to be wounded.

### ◎ Battery replacement

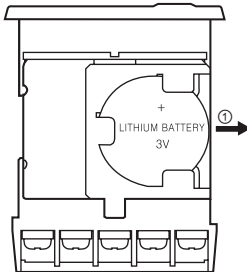

1. Detach the case.
2. Push the battery and detach it toward ①.
3. Insert a new battery with correct alignment of polarity pushing it toward opposite of ①.

※Since lithium battery is embedded in the product, follow instructions below for safety.

- ①Do not charge, short, disassemble, subject it to shock, heat.
- ②Check the polarity.
- ③Use CR2477 battery.
- ④Do not solder on a battery directly.
- ⑤Insulate a battery with tape to dispose .
- ⑥Do not store this unit in the place with the direct sunlight, high temperature and humidity.

※The battery is sold separately.

Please replace a battery by yourself. (sold separately)

※Do not burn up or disassemble the lithium battery.